

Tube Fittings

Features

- Sizes range from 1/16" and 1" or 2 mm to 38 mm.
- Diverse materials and configurations are available.
- Precision machined components ensure perfect deformation of the ferrules and tubing.
- Hardened threads with smooth surface finish avoid galling and help to extend the fitting service life.
- Female nut threads are silver-plated to reduce the friction against the body threads.
- Radius junction design with elbows provides smooth flow path.
- Every fitting is stamped with size, material, and heat code.
- Fittings are easy to disconnect and retighten.



Materials

Designator	Material	Bar Stock	Forging
B100	316 stainless steel	ASTM A276, ASME SA479, EN 1.4401	ASTM A182, ASME SA182, EN 1.4401
B110	304 stainless steel	ASTM A276, ASME SA479, EN 1.4301	ASTM A182, ASME SA182, EN 1.4301
B120	321 stainless steel	ASTM A276, ASME SA479, EN 1.4541	ASTM A182, ASME SA182, EN 1.4541
B200	Alloy 20	ASTM B473	ASTM B462
B210	Alloy 400/R-405	ASTM B164, ASME SB164	ASTM B564, ASME SB564
B220	Alloy 600	ASTM B166, ASME SB166	ASTM B564, ASME SB564
B230	Alloy C-276	ASTM B574	ASTM B564
B300	Brass	ASTM B16/B453	ASTM B283
B400	Carbon steel	ASTM A108	ASTM A105
B240	Duplex 2205	ASTM A479	ASTM A182
B250	Duplex 2507	ASTM A479	ASTM A182
B260	Titanium (grade 4)	ASTM B348	ASTM B381

Ordering Information

- Add material designator as a suffix to the basic ordering number to get the complete ordering number.
Example:
 1. Male connector with 14mm Tube, 1/2" NPT Male thread and 316 stainless steel material, the complete ordering number is 11101-10214-20108-B100.
 2. Union with 1/4" tube and 321 stainless steel material, the complete ordering number is 11100-10104-B120.

Installation Instructions

DECON tube fittings up to 1" or 25 mm.

1. Loosen the nut 1/4 turn from finger-tight position.
2. Insert tubing into the tube fitting, make sure that the tubing rests firmly on the shoulder of the port.
3. Finger-tighten the nut.
4. Tighten the nut 1 1/4 turns with wrench while holding steady the body of the fitting or the valve (Fig.1).
For small-sized fittings (1/16", 1/8" and 3/16", 2 mm, 3 mm and 4 mm), tighten the nut 3/4 turn with wrench(Fig.2).



Fig.1

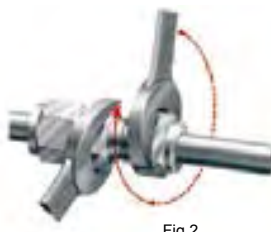

Fig.2

DECON tube fittings over 1" or 25 mm

1. Use presetting tool to install the ferrules onto the tube, please refer to the instruction of Hydraulic Presetting Tool for details.
2. Insert the preset tubing with ferrules and nut into the body of fitting, finger tight.
3. Tighten the nut one-half turn with wrench(Fig. 3, 4).



Fig.3



Fig.4

Reinstallation (all sizes)

1. Mark on the nut and body before disassembling the fitting.
2. Tighten the nut to the marked location before reinstallation.
3. Tighten the nut slightly with wrench.

Plugs and Port Connectors

1. Tighten the plug or port connector 1/4 turn from the finger-tight position while holding steady the body of the fitting.
For small-sized fittings (1/16", 1/8" and 3/16", 2 mm, 3 mm and 4 mm), tighten the nut 1/8 turn with wrench.
2. Reinstallation: Tighten slightly with a wrench from the finger-tight position.
The Installation Instructions of the tube adapter end of Port Connectors are the same as the DECON Tube Fittings.

Cautions

- Do not loosen or tighten fittings when system is pressurized.
- Make sure that the tubing rests firmly on the shoulder of the port.
- Always leave enough straight length of the tubing for the fittings.
- Always use an insert for extremely soft plastic tubing.
- Material of the metal tubing should be softer than that of the fitting. For example, stainless steel tubing should not be used with brass fittings. When tubing and fittings are made of the same material, the tubing must be fully annealed.
- The allowable working pressure of the tube fitting is rated to the maximum working pressure of the corresponding tubing, which can be found in DECON tubing data sheet. For those which can not be found in DECON tubing data sheet, please contact the authorized representative or DECON for related information.
- Keep the tubing end and surface clean and smooth.
- Always use proper thread sealants on tapered pipe threads. Make sure that its working temperature does not exceed that of the sealants.
- When assemble the tube fitting, hold the body with a wrench and turn the nut instead of holding the nut.
- When install a valve with tube fitting end, hold the valve body with a wrench and turn the nut.
- When assemble the fitting to a valve with thread, hold the valve body with a wrench and turn the body of the fitting.

Male Connectors 4 - 8

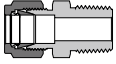

Bulkhead Male Connectors 9

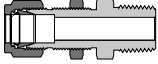

Thermocouple Connectors 10

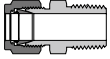

Female Connectors 11 - 15

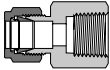

Bulkhead Female Connectors 16

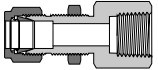

Unions 17



Conversion Unions 18



Reducing Unions 18 - 19

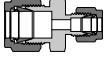

Bulkhead Unions 20

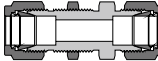

Bulkhead Reducing Unions 20

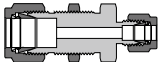

Bulkhead Conversion Unions 21

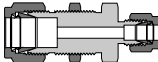

Bulkhead Locknuts 21



Male Elbows 22 - 24

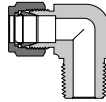

45° Male Elbows 25

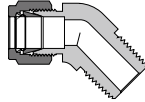

Female Elbows 26

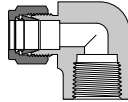

Union Elbows 27

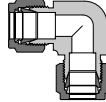

Union Reducing Elbows 28

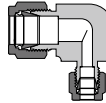

Male Branch Tees 29

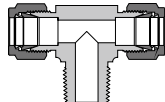

Male Run Tees 30

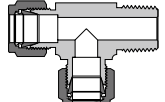

Female Branch Tees 31

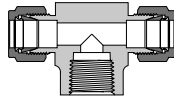

Female Run Tees 32

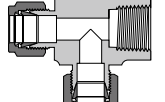

Union Tees 33

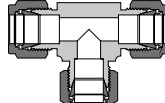

Reducing Union Tees 34 - 35

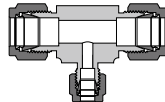

Union Crosses 36

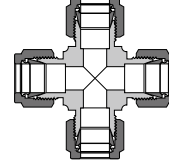

Caps 36



Plugs 37



Nuts 37



Front Ferrules 38



Rear Ferrules 38



Nuts + Ferrules 38



Nut-Ferrule Sets 39



Ferrule Sets 39



Weld Connectors 40 - 41

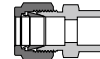

Weld Elbows 41 - 42

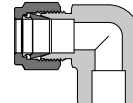

RP, RG Gaskets 43



Male Connectors

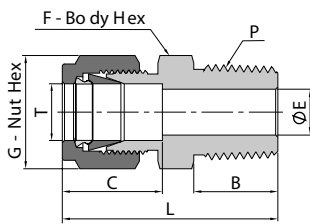

Fractional Tube			NPT Thread					
T-Tube O.D. (in.)	P-NPT Size	Basic Ordering Number	Dimension,mm					
			L	B	C	E	G	F
1/16	1/16	11101-10101-20101-	32.9	9.7	8.6	1.3	7.9	7.9
1/16	1/8	11101-10101-20102-	26.2	9.7	8.6	1.3	7.9	11.1
1/16	1/4	11101-10101-20104-	31.0	14.2	8.6	1.3	7.9	14.3
1/8	1/16	11101-10102-20101-	29.7	9.7	12.7	2.3	11.1	11.1
1/8	1/8	11101-10102-20102-	30.5	9.7	12.7	2.3	11.1	11.1
1/8	1/4	11101-10102-20104-	35.6	14.2	12.7	2.3	11.1	14.3
1/8	3/8	11101-10102-20106-	35.8	14.2	12.7	2.3	11.1	17.5
1/8	1/2	11101-10102-20108-	42.2	19.1	12.7	2.3	11.1	22.2
3/16	1/16	11101-10103-20101-	31.20	9.70	13.70	2.30	12.70	11.10
3/16	1/8	11101-10103-20102-	31.20	9.70	13.70	3.00	12.70	11.10
3/16	1/4	11101-10103-20104-	36.30	14.20	13.70	3.00	12.70	14.30
1/4	1/16	11101-10104-20101-	32.80	9.70	15.20	3.00	14.30	12.70
1/4	1/8	11101-10104-20102-	32.80	9.70	15.20	4.80	14.30	12.70
1/4	1/4	11101-10104-20104-	37.80	14.20	15.20	4.80	14.30	14.30
1/4	3/8	11101-10104-20106-	38.40	14.20	15.20	4.80	14.30	17.50
1/4	1/2	11101-10104-20108-	44.70	19.10	15.20	4.80	14.30	22.20
1/4	3/4	11101-10104-20112-	46.20	19.10	15.20	4.80	14.30	27.00
5/16	1/8	11101-10105-20102-	34.00	9.70	16.30	4.80	15.90	14.30
5/16	1/4	11101-10105-20104-	38.60	9.70	16.30	6.40	15.90	14.30
5/16	3/8	11101-10105-20106-	39.10	14.20	16.30	6.40	15.90	17.50
5/16	1/2	11101-10105-20108-	45.50	19.10	16.30	6.40	15.90	22.20
3/8	1/8	11101-10106-20102-	35.30	9.70	16.80	4.80	17.50	15.90
3/8	1/4	11101-10106-20104-	39.90	14.20	16.80	7.10	17.50	15.90
3/8	3/8	11101-10106-20106-	39.90	14.20	16.80	7.10	17.50	17.50
3/8	1/2	11101-10106-20108-	46.20	19.10	16.80	7.10	17.50	22.20
3/8	3/4	11101-10106-20112-	47.80	19.10	16.80	7.10	17.50	27.00
3/8	1	11101-10106-20116-	47.00	23.90	16.80	7.10	17.50	34.90
1/2	1/8	11101-10108-20102-	38.90	9.70	22.90	4.80	22.20	20.60
1/2	1/4	11101-10108-20104-	43.40	14.20	22.90	7.10	22.20	20.60
1/2	3/8	11101-10108-20106-	43.40	14.20	22.90	9.70	22.20	20.60
1/2	1/2	11101-10108-20108-	49.00	19.10	22.90	10.40	22.20	22.20
1/2	3/4	11101-10108-20112-	50.50	19.10	22.90	10.40	22.20	27.00
1/2	1	11101-10108-20116-	57.20	23.90	22.90	10.40	22.20	34.90
5/8	1/4	11101-10110-20104-	44.20	14.20	24.40	7.10	25.40	23.80
5/8	3/8	11101-10110-20106-	44.20	14.20	24.40	9.70	25.40	23.80
5/8	1/2	11101-10110-20108-	49.00	19.10	24.40	11.90	25.40	23.80
5/8	3/4	11101-10110-20112-	50.50	19.10	24.40	12.70	25.40	27.00
3/4	3/8	11101-10112-20106-	45.70	14.20	24.40	10.40	28.60	27.00
3/4	1/2	11101-10112-20108-	50.50	19.10	24.40	11.90	28.60	27.00
3/4	3/4	11101-10112-20112-	50.50	19.10	24.40	15.70	28.60	27.00
3/4	1	11101-10112-20116-	57.20	23.90	24.40	15.70	28.60	34.90
7/8	1/2	11101-10114-20108-	50.50	19.10	25.90	11.90	31.80	30.20
7/8	3/4	11101-10114-20112-	50.50	19.10	25.90	15.70	31.80	30.20
7/8	1	11101-10114-20116-	57.20	23.90	25.90	18.30	31.80	34.90
1	1/2	11101-10116-20108-	57.40	19.10	31.20	11.90	38.10	34.90
1	3/4	11101-10116-20112-	57.40	19.10	31.20	15.70	38.10	34.90
1	1	11101-10116-20116-	62.20	23.90	31.20	22.40	38.10	34.90
1 1/8	1	11101-10118-20116-	62.20	23.90	31.20	22.40	46.00	41.30
1 1/4	1	11101-10120-20116-	77.20	23.90	41.10	22.40	47.60	44.50
1 1/4	1 1/4	11101-10120-20120-	77.20	23.90	41.10	27.70	47.60	44.50
1 1/2	1 1/2	11101-10124-20124-	88.90	26.20	50.00	34.00	57.20	54.00

1. Dimensions are for reference only, subject to change.
 2. Dimensions shown are in finger-tight position.

Male Connectors

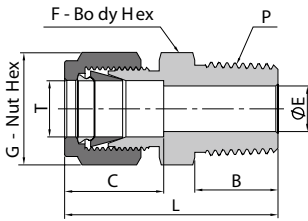

Fractional Tube			ISO Tapered Thread(RT)					
T-Tube O.D. (in.)	P-RT Size	Basic Ordering Number	Dimension,mm					
			L	B	C	E	G	F
1/8	1/8	11101-10102-30102-	30.50	9.70	12.70	2.30	11.10	11.10
1/8	1/4	11101-10102-30104-	35.60	14.20	12.70	2.30	11.10	14.30
1/4	1/8	11101-10104-30102-	32.80	9.70	15.20	4.80	14.30	12.70
1/4	1/4	11101-10104-30104-	37.80	14.20	15.20	4.80	14.30	14.30
1/4	3/8	11101-10104-30106-	38.40	14.20	15.20	4.80	14.30	17.50
1/4	1/2	11101-10104-30108-	44.70	19.10	15.20	4.80	14.30	22.20
5/16	1/8	11101-10105-30102-	34.00	9.70	16.30	4.80	15.90	14.30
5/16	1/4	11101-10105-30104-	38.60	9.70	16.30	6.40	15.90	14.30
3/8	1/8	11101-10106-30102-	35.30	9.70	16.80	4.80	17.50	15.90
3/8	1/4	11101-10106-30104-	39.90	14.20	16.80	7.10	17.50	15.90
3/8	3/8	11101-10106-30106-	39.90	14.20	16.80	7.10	17.50	17.50
3/8	1/2	11101-10106-30108-	46.20	19.10	16.80	7.10	17.50	22.20
3/8	3/4	11101-10106-30112-	47.80	19.10	16.80	7.10	17.50	27.00
1/2	1/4	11101-10108-30104-	43.40	14.20	22.90	7.10	22.20	20.60
1/2	3/8	11101-10108-30106-	43.40	14.20	22.90	9.70	22.20	20.60
1/2	1/2	11101-10108-30108-	49.00	19.10	22.90	10.40	22.20	22.20
1/2	3/4	11101-10108-30112-	50.50	19.10	22.90	10.40	22.20	27.00
5/8	1/2	11101-10110-30108-	49.00	19.10	24.40	11.90	25.40	23.80
3/4	3/4	11101-10112-30112-	50.50	19.10	24.40	15.70	28.60	27.00
3/4	1	11101-10112-30116-	57.20	23.90	24.40	15.70	28.60	34.90
1	3/4	11101-10116-30112-	57.40	19.10	31.20	15.70	38.10	34.90
1	1	11101-10116-30116-	62.20	23.90	31.20	22.40	38.10	34.90

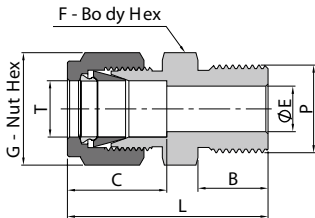

Fractional Tube			ISO Parallel Thread(BP)					
T-Tube O.D. (in.)	P-BP Size	Basic Ordering Number	Dimension,mm					
			L	B	C	E	G	F
1/4	3/8	11101-10104-40106-	38.40	14.20	15.20	4.80	14.30	17.50
3/8	3/8	11101-10106-40106-	39.90	14.20	16.80	7.10	17.50	17.50

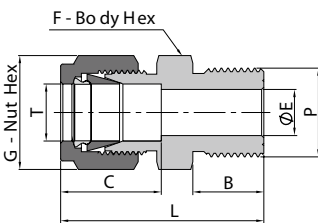

Fractional Tube			Metric Thread(MS)					
T-Tube O.D. (in.)	P-Metric Thread Size	Basic Ordering Number	Dimension,mm					
			L	B	C	E	G	F
1/16	M5 x 0.8	11101-10101-50505-	21.80	8	8.60	1.30	7.90	7.90
1/8	M14 x 1.5	11101-10102-50514-	34.80	13	12.70	2.30	11.10	15.90
1/8	M16 x 1.5	11101-10102-50516-	35.80	14	12.70	2.30	11.10	17.50
1/8	M18 x 1.5	11101-10102-50518-	37.20	15	12.70	2.30	11.10	19.10
1/8	M20 x 1.5	11101-10102-50520-	38.20	16	12.70	2.30	11.10	22.20
1/4	M14 x 1.5	11101-10104-50514-	36.90	13	15.20	4.80	14.30	15.90
1/4	M16 x 1.5	11101-10104-50516-	38.10	14	15.20	4.80	14.30	17.50
1/4	M18 x 1.5	11101-10104-50518-	39.50	15	15.20	4.80	14.30	19.10
1/4	M20 x 1.5	11101-10104-50520-	40.70	16	15.20	4.80	14.30	22.20
3/8	M10 x 1.0	11101-10106-50510-	36.40	11	16.80	4.80	17.50	15.90
3/8	M14 x 1.5	11101-10106-50514-	39.30	13	16.80	7.10	17.50	15.90
3/8	M16 x 1.5	11101-10106-50516-	39.70	14	16.80	7.10	17.50	17.50
3/8	M18 x 1.5	11101-10106-50518-	41.50	15	16.80	7.10	17.50	19.10
3/8	M20 x 1.5	11101-10106-50520-	42.30	16	16.80	7.10	17.50	22.20
1/2	M16 x 1.5	11101-10108-50516-	43.20	14	22.90	8.40	22.20	20.60
1/2	M18 x 1.5	11101-10108-50518-	43.70	15	22.90	9.60	22.20	20.60
1/2	M20 x 1.5	11101-10108-50520-	44.90	16	22.90	10.40	22.20	22.20
1/2	M22 x 1.5	11101-10108-50522-	47.00	17	22.90	10.40	22.20	23.80

Male Connectors

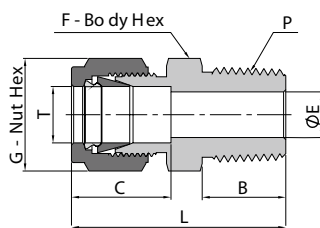

Metric Tube			NPT Thread						
T-Tube O.D. (mm)	P-NPT Size	Basic Ordering Number	Dimension,mm						
			L	B	C	E	G	F	
2	1/8	11101-10202-20102-	30.50	9.70	12.90	1.70	12	12	
3	1/8	11101-10203-20102-	30.50	9.70	12.90	2.40	12	12	
3	1/4	11101-10203-20104-	35.60	14.20	12.90	2.40	12	14	
4	1/8	11101-10204-20102-	31.20	9.70	13.70	2.40	12	12	
4	1/4	11101-10204-20104-	36.30	14.20	13.70	2.40	12	14	
6	1/8	11101-10206-20102-	32.80	9.70	15.30	4.80	14	14	
6	1/4	11101-10206-20104-	37.90	14.20	15.30	4.80	14	14	
6	3/8	11101-10206-20106-	38.40	14.20	15.30	4.80	14	18	
6	1/2	11101-10206-20108-	44.70	19.10	15.30	4.80	14	22	
8	1/8	11101-10208-20102-	34.20	9.70	16.20	4.80	16	15	
8	1/4	11101-10208-20104-	38.70	14.20	16.20	6.40	16	15	
8	3/8	11101-10208-20106-	39.30	14.20	16.20	6.40	16	18	
8	1/2	11101-10208-20108-	45.60	19.10	16.20	6.40	16	22	
10	1/8	11101-10210-20102-	36.30	9.70	17.20	4.80	19	18	
10	1/4	11101-10210-20104-	40.90	14.20	17.20	7.10	19	18	
10	3/8	11101-10210-20106-	40.90	14.20	17.20	7.90	19	18	
10	1/2	11101-10210-20108-	46.50	19.10	17.20	7.90	19	22	
10	3/4	11101-10210-20112-	48.00	19.10	17.20	7.90	19	27	
10	1	11101-10210-20116-	54.60	23.90	17.20	7.90	19	35	
12	1/8	11101-10212-20102-	38.80	9.70	22.80	4.80	22	22	
12	1/4	11101-10212-20104-	43.40	14.20	22.80	7.10	22	22	
12	3/8	11101-10212-20106-	43.40	14.20	22.80	9.50	22	22	
12	1/2	11101-10212-20108-	49.00	19.10	22.80	9.50	22	22	
12	3/4	11101-10212-20112-	50.50	19.10	22.80	9.50	22	27	
14	1/8	11101-10214-20102-	38.80	9.70	24.40	4.80	25	24	
14	1/4	11101-10214-20104-	44.10	14.20	24.40	7.10	25	24	
14	3/8	11101-10214-20106-	44.10	14.20	24.40	9.50	25	24	
14	1/2	11101-10214-20108-	49.00	19.10	24.40	11.10	25	24	
14	3/4	11101-10214-20112-	50.50	19.10	24.40	11.10	25	27	
15	1/2	11101-10215-20108-	49.00	19.10	24.40	11.90	25	24	
15	3/4	11101-10215-20112-	50.50	19.10	24.40	11.90	25	27	
15	1	11101-10215-20116-	57.10	23.90	24.40	11.90	25	35	
16	1/4	11101-10216-20104-	44.10	14.20	24.40	7.10	25	24	
16	3/8	11101-10216-20106-	44.10	14.20	24.40	9.50	25	24	
16	1/2	11101-10216-20108-	49.00	19.10	24.40	11.90	25	24	
16	3/4	11101-10216-20112-	50.50	19.10	24.40	12.70	25	27	
18	3/8	11101-10218-20106-	45.60	14.20	24.40	9.50	30	27	
18	1/2	11101-10218-20108-	50.50	19.10	24.40	11.90	30	27	
18	3/4	11101-10218-20112-	50.50	19.10	24.40	15.10	30	27	
20	1/2	11101-10220-20108-	52.30	19.10	26.00	11.90	32	30	
20	3/4	11101-10220-20112-	52.30	19.10	26.00	15.90	32	30	
20	1	11101-10220-20116-	57.10	23.90	26.00	15.90	32	35	
22	1/2	11101-10222-20108-	52.30	19.10	26.00	11.90	32	30	
22	3/4	11101-10222-20112-	52.30	19.10	26.00	15.90	32	30	
22	1	11101-10222-20116-	57.10	23.90	26.00	18.30	32	35	
25	1/2	11101-10225-20108-	57.50	19.10	31.30	11.90	38	35	
25	3/4	11101-10225-20112-	57.50	19.10	31.30	15.90	38	35	
25	1	11101-10225-20116-	62.30	23.90	31.30	21.80	38	35	
28	1	11101-10228-20116-	72.40	23.90	36.60	21.80	46	41	
28	1 1/4	11101-10228-20120-	73.10	23.90	36.60	21.80	46	46	
30	1 1/4	11101-10230-20120-	77.20	23.90	39.60	26.20	50	46	
32	1 1/4	11101-10232-20120-	79.60	23.90	42.00	28.60	50	46	
38	1 1/2	11101-10238-20124-	91.60	26.20	49.40	33.70	60	55	

Male Connectors

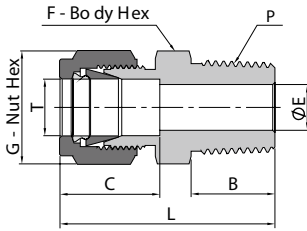

Metric Tube			ISO Tapered Thread(RT)						
T-Tube O.D. (mm)	P-RT Size	Basic Ordering Number	Dimension,mm						
			L	B	C	E	G	F	
2	1/8	11101-10202-30102-	30.5	9.7	12.9	1.7	12	12	
3	1/8	11101-10203-30102-	30.5	9.7	12.9	2.4	12	12	
3	1/4	11101-10203-30104-	35.6	14.2	12.9	2.4	12	14	
4	1/8	11101-10204-30102-	31.2	9.7	13.7	2.4	12	12	
4	1/4	11101-10204-30104-	36.3	14.2	13.7	2.4	12	14	
6	1/8	11101-10206-30102-	32.8	9.7	15.3	4.8	14	14	
6	1/4	11101-10206-30104-	37.9	14.2	15.3	4.8	14	14	
6	3/8	11101-10206-30106-	38.4	14.2	15.3	4.8	14	18	
6	1/2	11101-10206-30108-	44.7	19.1	15.3	4.8	14	22	
8	1/8	11101-10208-30102-	34.2	9.7	16.2	4.8	16	15	
8	1/4	11101-10208-30104-	38.7	14.2	16.2	6.4	16	15	
8	3/8	11101-10208-30106-	39.2	14.2	16.2	6.4	16	18	
8	1/2	11101-10208-30108-	45.6	19.1	16.2	6.4	16	22	
10	1/8	11101-10210-30102-	36.3	9.7	17.2	4.8	19	18	
10	1/4	11101-10210-30104-	40.9	14.2	17.2	7.1	19	18	
10	3/8	11101-10210-30106-	40.9	14.2	17.2	7.9	19	18	
10	1/2	11101-10210-30108-	46.5	19.1	17.2	7.9	19	22	
10	3/4	11101-10210-30112-	48.0	19.1	17.2	7.9	19	27	
12	1/8	11101-10212-30102-	38.3	9.7	22.8	4.8	22	22	
12	1/4	11101-10212-30104-	43.4	14.2	22.8	7.1	22	22	
12	3/8	11101-10212-30106-	43.4	14.2	22.8	9.5	22	22	
12	1/2	11101-10212-30108-	49.0	19.1	22.8	9.5	22	22	
12	3/4	11101-10212-30112-	50.5	19.1	22.8	9.5	22	27	
14	1/8	11101-10214-30102-	38.8	9.7	24.4	4.8	25	24	
14	1/4	11101-10214-30104-	44.1	14.2	24.4	7.1	25	24	
14	3/8	11101-10214-30106-	44.1	14.2	24.4	7.9	25	24	
14	1/2	11101-10214-30108-	49.0	19.1	24.4	11.1	25	24	
14	3/4	11101-10214-30112-	50.5	19.1	24.4	11.1	25	27	
15	1/2	11101-10215-30108-	49.0	19.1	24.4	11.9	25	24	
16	1/4	11101-10216-30104-	44.1	14.2	24.4	7.1	25	24	
16	3/8	11101-10216-30106-	44.1	14.2	24.4	9.5	25	24	
16	1/2	11101-10216-30108-	49.0	19.1	24.4	11.9	25	24	
16	3/4	11101-10216-30112-	50.5	19.1	24.4	12.7	25	27	
18	1/2	11101-10218-30108-	50.5	19.1	24.4	11.9	30	27	
18	3/4	11101-10218-30112-	50.5	19.1	24.4	15.1	30	27	
20	1/2	11101-10220-30108-	52.3	19.1	26.0	11.9	32	30	
20	3/4	11101-10220-30112-	52.3	19.1	26.0	15.9	32	30	
22	3/4	11101-10222-30112-	52.3	19.1	26.0	15.9	32	30	
22	1	11101-10222-30116-	57.1	23.9	26.0	18.3	32	35	
25	1/2	11101-10225-30108-	57.5	19.1	31.3	11.9	38	35	
25	3/4	11101-10225-30112-	57.5	19.1	31.3	15.9	38	35	
25	1	11101-10225-30116-	62.3	23.9	31.3	21.8	38	35	
28	1	11101-10228-30116-	72.4	23.9	36.6	21.8	46	41	
28	1 1/4	11101-10228-30120-	73.1	23.9	36.6	21.8	46	46	
30	1 1/4	11101-10230-30120-	77.2	23.9	39.6	26.2	50	46	
32	1 1/4	11101-10232-30120-	79.6	23.9	42.0	28.6	50	46	
38	1 1/2	11101-10238-30124-	91.6	26.2	49.4	33.7	60	55	

Male Connectors

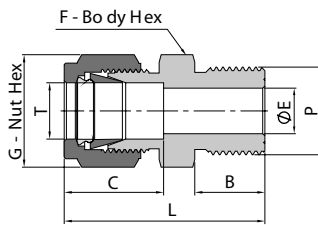

Metric Tube			ISO Parallel Thread(BP)					
P-Tube O.D. (mm)	P-BP Size	Basic Ordering Number	Dimension,mm					
			L	B	C	E	G	F
6	1/4	11101-10206-40104-	36.9	12.9	15.3	4.8	14	14
6	3/8	11101-10206-40106-	39.5	14.2	15.3	4.8	14	18
8	1/8	11101-10208-40102-	33.9	9.8	16.2	4.0	16	14
8	1/4	11101-10208-40104-	37.0	12.9	16.2	6.4	16	14
8	3/8	11101-10208-40106-	39.3	14.2	16.2	6.4	16	18
8	1/2	11101-10208-40108-	45.4	18.8	16.2	6.4	16	22
10	1/4	11101-10210-40104-	39.5	12.9	17.2	5.9	19	18
10	1/2	11101-10210-40108-	46.3	18.8	17.2	7.9	19	22
12	3/8	11101-10212-40106-	44.2	14.2	22.8	7.9	22	22
12	1/2	11101-10212-40108-	49.0	18.8	22.8	9.5	22	22
14	1/4	11101-10214-40104-	42.9	12.9	24.4	5.9	25	24
16	3/8	11101-10216-40106-	43.4	14.2	24.4	7.9	25	24
16	1/2	11101-10216-40108-	47.9	18.8	24.4	9.5	25	24
18	1/2	11101-10218-40108-	49.8	18.8	24.4	9.5	30	27

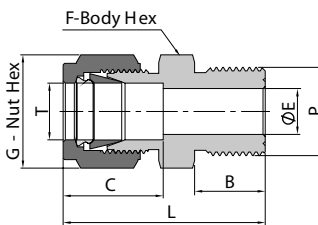

Metric Tube			Metric Thread(MS)					
T-Tube O.D. (mm)	P-Metric Thread Size	Basic Ordering Number	Dimension,mm					
			L	B	C	E	G	F
6	M 6 x 1	11101-10206-50506-	32.4	8	15.3	2.0	14	14
6	M 8 x 1	11101-10206-50508-	32.4	9	15.3	3.0	14	14
6	M 10 x 1	11101-10206-50510-	35.2	11	15.3	4.7	14	14
6	M 12 x 1.5	11101-10206-50512-	36.4	12	15.3	4.8	14	14
6	M 14 x 1.5	11101-10206-50514-	37.4	13	15.3	4.8	14	16
6	M 16 x 1.5	11101-10206-50516-	38.4	14	15.3	4.8	14	18
6	M 18 x 1.5	11101-10206-50518-	40.0	15	15.3	4.8	14	19
6	M 20 x 1.5	11101-10206-50520-	41.7	16	15.3	4.8	14	22
8	M 8 x 1	11101-10208-50508-	34.5	9	16.2	3.0	16	14
8	M 10 x 1	11101-10208-50510-	35.6	11	16.2	4.7	16	14
8	M 12 x 1.5	11101-10208-50512-	36.6	12	16.2	6.0	16	14
8	M 14 x 1.5	11101-10208-50514-	37.7	13	16.2	6.4	16	16
8	M 20 x 1.5	11101-10208-50520-	42.5	16	16.2	6.4	16	22
10	M 12 x 1.5	11101-10210-50512-	38.7	12	17.2	6.0	19	18
10	M 14 x 1.5	11101-10210-50514-	39.7	13	17.2	7.2	19	18
10	M 20 x 1.5	11101-10210-50520-	43.5	16	17.2	7.9	19	22
12	M 12 x 1.5	11101-10212-50512-	41.2	12	22.8	6.0	22	22
12	M 16 x 1.5	11101-10212-50516-	43.2	14	22.8	9.5	22	22
12	M 18 x 1.5	11101-10212-50518-	44.2	15	22.8	9.5	22	22
12	M 20 x 1.5	11101-10212-50520-	45.2	16	22.8	9.5	22	22
14	M 14 x 1.5	11101-10214-50514-	42.5	13	24.4	7.2	25	24
14	M 16 x 1.5	11101-10214-50516-	43.9	14	24.4	8.4	25	24
14	M 20 x 1.5	11101-10214-50520-	45.1	16	24.4	10.8	25	24
16	M 20 x 1.5	11101-10216-50520-	46.1	16	24.4	10.8	25	24
18	M 20 x 1.5	11101-10218-50520-	47.5	16	24.4	10.8	30	27
18	M 22 x 1.5	11101-10218-50522-	48.5	17	24.4	12	30	27
20	M 20 x 1.5	11101-10220-50520-	49.5	16	26.0	10.8	32	30
22	M 24 x 1.5	11101-10222-50524-	50.5	17	26.0	14.4	32	30
25	M 27 x 2	11101-10225-50527-	57.0	18	31.3	16.1	38	35

Bulkhead Male Connectors

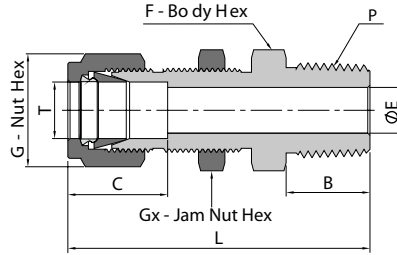

Fractional Tube										NPT Thread	
T-Tube O.D. (in.)	P-NPT Size	Basic Ordering Number	Dimension,mm							Panel Hole Size (mm)	Max.Panel Thickness (mm)
			L	B	C	E	G	F	Gx		
1/16	1/16	11111-10101-20101-	30.2	9.7	8.6	1.3	7.9	7.9	7.9	5.2	6.4
1/16	1/8	11111-10101-20102-	32.3	9.7	8.6	1.3	7.9	11.1	7.9	5.2	6.4
1/8	1/8	11111-10102-20102-	46.5	9.7	12.7	2.3	11.1	12.7	12.7	8.3	12.7
3/16	1/8	11111-10103-20102-	48.0	9.7	13.7	3.0	12.7	14.3	14.3	9.9	12.7
1/4	1/8	11111-10104-20102-	49.5	9.7	15.2	4.8	14.3	15.9	15.9	11.5	10.2
1/4	1/4	11111-10104-20104-	54.1	14.2	15.2	4.8	14.3	15.9	15.9	11.5	10.2
1/4	3/8	11111-10104-20106-	54.9	14.2	15.2	4.8	14.3	17.5	15.9	11.5	10.2
1/4	1/2	11111-10104-20108-	60.3	19.1	15.2	4.8	14.3	22.2	15.9	11.5	10.2
5/16	1/8	11111-10105-20102-	52.8	9.7	16.3	4.8	15.9	17.5	17.5	13.1	11.2
5/16	1/4	11111-10105-20104-	57.7	14.2	16.3	6.4	15.9	17.5	17.5	13.1	11.2
3/8	1/8	11111-10106-20102-	52.9	9.7	16.8	4.8	17.5	19.1	19.1	14.7	11.2
3/8	1/4	11111-10106-20104-	57.4	14.2	16.8	7.1	17.5	19.1	19.1	14.7	11.2
3/8	3/8	11111-10106-20106-	57.4	14.2	16.8	7.1	17.5	19.1	19.1	14.7	11.2
3/8	1/2	11111-10106-20108-	63.8	19.1	16.8	7.1	17.5	22.2	19.1	14.7	11.2
1/2	1/8	11111-10108-20102-	58.7	9.7	22.9	4.8	22.2	23.8	23.8	19.4	12.7
1/2	1/4	11111-10108-20104-	63.2	14.2	22.9	7.1	22.2	23.8	23.8	19.4	12.7
1/2	3/8	11111-10108-20106-	63.2	14.2	22.9	9.7	22.2	23.8	23.8	19.4	12.7
1/2	1/2	11111-10108-20108-	68.8	19.1	22.9	10.4	22.2	23.8	23.8	19.4	12.7
5/8	3/8	11111-10110-20106-	66.7	14.2	24.4	9.7	25.4	27.0	27.0	22.6	15.1
5/8	1/2	11111-10110-20108-	71.5	19.1	24.4	11.9	25.4	27.0	27.0	22.6	15.1
3/4	1/2	11111-10112-20108-	76.2	19.1	24.4	11.9	28.6	30.2	30.2	25.8	16.8
3/4	3/4	11111-10112-20112-	76.2	19.1	24.4	15.7	28.6	30.2	30.2	25.8	16.8
7/8	3/4	11111-10114-20112-	84.1	19.1	25.9	15.7	31.8	33.3	33.3	29.0	19.1
1	3/4	11111-10116-20112-	88.4	19.1	31.2	15.7	38.1	41.3	41.3	33.7	19.1
1	1	11111-10116-20116-	93.2	23.9	31.2	22.4	38.1	41.3	41.3	33.7	19.1

Metric Tube										NPT Thread	
T-Tube O.D. (mm)	P-NPT Size	Basic Ordering Number	Dimension,mm							Panel Hole Size (mm)	Max.Panel Thickness (mm)
			L	B	C	E	G	F	Gx		
6	1/8	11111-10206-20102-	49.6	9.7	15.3	4.8	14	16	16	11.5	10.2
6	1/4	11111-10206-20104-	53.6	14.2	15.3	4.8	14	16	16	11.5	10.2
8	1/8	11111-10208-20102-	52.3	9.7	16.2	4.8	16	18	18	13.1	11.2
8	1/4	11111-10208-20104-	57.5	14.2	16.2	6.4	16	18	18	13.1	11.2
10	1/4	11111-10210-20104-	58.4	14.2	17.2	7.9	19	22	22	16.3	11.2
10	3/8	11111-10210-20106-	58.4	14.2	17.2	7.9	19	22	22	16.3	11.2
10	1/2	11111-10210-20108-	63.1	19.1	17.2	7.9	19	22	22	16.3	11.2
12	1/4	11111-10212-20104-	63.9	14.2	22.8	7.9	22	24	24	19.5	12.7
12	3/8	11111-10212-20106-	63.9	14.2	22.8	9.5	22	24	24	19.5	12.7
12	1/2	11111-10212-20108-	68.8	19.1	22.8	9.5	22	24	24	19.5	12.7

Thermocouple Connectors

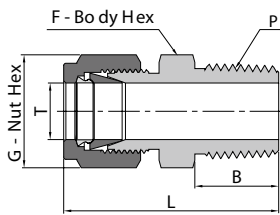

Fractional Tube			NPT Thread			
T-Tube O.D. (in.)	P-NPT Size	Basic Ordering Number	Dimension,mm			
			L	B	G	F
1/ 16	1/ 16	11105-10101-20101-	23.9	9.7	7.9	7.9
1/ 16	1/ 8	11105-10101-20102-	26.2	9.7	7.9	11.1
1/ 16	1/ 4	11105-10101-20104-	31.0	14.2	7.9	14.3
1/ 8	1/ 16	11105-10102-20101-	29.7	9.7	11.1	11.1
1/ 8	1/ 8	11105-10102-20102-	30.5	9.7	11.1	11.1
1/ 8	1/ 4	11105-10102-20104-	35.6	14.2	11.1	14.3
3/ 16	1/ 8	11105-10103-20102-	31.2	9.7	12.7	11.1
3/ 16	1/ 4	11105-10103-20104-	36.3	14.2	12.7	14.3
1/ 4	1/ 8	11105-10104-20102-	32.8	9.7	14.3	12.7
1/ 4	1/ 4	11105-10104-20104-	37.8	14.2	14.3	14.3
1/ 4	3/ 8	11105-10104-20106-	38.4	14.2	14.3	17.5
1/ 4	1/ 2	11105-10104-20108-	44.7	19.1	14.3	22.2
5/ 16	1/ 4	11105-10105-20104-	38.6	14.2	15.9	14.3
3/ 8	1/ 4	11105-10106-20104-	39.9	14.2	17.5	15.9
3/ 8	3/ 8	11105-10106-20106-	39.9	14.2	17.5	17.5
3/ 8	1/ 2	11105-10106-20108-	46.2	19.1	17.5	22.2
3/ 8	3/ 4	11105-10106-20112-	47.8	19.1	17.5	27.0
1/ 2	1/ 2	11105-10108-20108-	49.0	19.1	22.2	22.2
1/ 2	3/ 4	11105-10108-20112-	50.5	19.1	22.2	27.0
5/ 8	3/ 4	11105-10110-20112-	50.5	19.1	25.4	27.0
3/ 4	3/ 4	11105-10112-20112-	50.5	19.1	28.6	27.0
1	1	11105-10116-20116-	62.2	23.9	38.1	34.9

Female Connectors

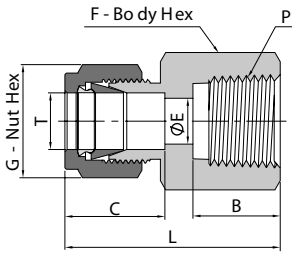

Fractional Tube			NPT Thread					
T-Tube O.D. (in.)	P-NPT Size	Basic Ordering Number	Dimension,mm					
			L	B	C	E	G	F
1/ 16	1/ 16	11102-10101-21101-	23.6	9.9	8.6	1.3	7.9	11.1
1/ 16	1/ 8	11102-10101-21102-	24.4	10.4	8.6	1.3	7.9	14.3
1/ 8	1/ 8	11102-10102-21102-	28.7	10.4	12.7	2.3	11.1	14.3
1/ 8	1/ 4	11102-10102-21104-	33.5	15.0	12.7	2.3	11.1	19.1
3/ 16	1/ 8	11102-10103-21102-	29.7	10.4	13.7	3.0	12.7	14.3
1/ 4	1/ 8	11102-10104-21102-	31.2	10.4	15.2	4.8	14.3	14.3
1/ 4	1/ 4	11102-10104-21104-	35.8	15.0	15.2	4.8	14.3	19.1
1/ 4	3/ 8	11102-10104-21106-	37.6	15.0	15.2	4.8	14.3	22.2
1/ 4	1/ 2	11102-10104-21108-	42.4	19.8	15.2	4.8	14.3	27.0
5/ 16	1/ 8	11102-10105-21102-	32.0	10.4	16.3	6.4	15.9	14.3
5/ 16	1/ 4	11102-10105-21104-	36.8	15.0	16.3	6.4	15.9	19.1
3/ 8	1/ 8	11102-10106-21102-	32.8	10.4	16.8	7.1	17.5	15.9
3/ 8	1/ 4	11102-10106-21104-	37.6	15.0	16.8	7.1	17.5	19.1
3/ 8	3/ 8	11102-10106-21106-	39.1	15.0	16.8	7.1	17.5	22.2
3/ 8	1/ 2	11102-10106-21108-	43.9	19.8	16.8	7.1	17.5	27.0
3/ 8	3/ 4	11102-10106-21112-	47.8	20.6	16.8	7.1	17.5	33.3
1/ 2	1/ 4	11102-10108-21104-	40.4	15.0	22.9	10.4	22.2	20.6
1/ 2	3/ 8	11102-10108-21106-	41.9	15.0	22.9	10.4	22.2	22.2
1/ 2	1/ 2	11102-10108-21108-	46.7	19.8	22.9	10.4	22.2	27.0
1/ 2	3/ 4	11102-10108-21112-	48.3	20.6	22.9	10.4	22.2	33.3
5/ 8	3/ 8	11102-10110-21106-	41.9	15.0	24.4	12.7	25.4	23.8
5/ 8	1/ 2	11102-10110-21108-	46.7	19.8	24.4	12.7	25.4	27.0
3/ 4	1/ 2	11102-10112-21108-	46.7	19.8	24.4	15.7	28.6	27.0
3/ 4	3/ 4	11102-10112-21112-	48.3	20.6	24.4	15.7	28.6	33.3
7/ 8	3/ 4	11102-10114-21112-	49.8	20.6	25.9	18.3	31.8	33.3
1	3/ 4	11102-10116-21112-	53.3	20.6	31.2	22.4	38.1	34.9
1	1	11102-10116-21116-	62.2	25.4	31.2	22.4	38.1	41.3
1 1/ 4	1 1/ 4	11102-10120-21120-	74.7	25.4	41.1	27.7	47.6	54.0
1 1/ 2	1 1/ 2	11102-10124-21124-	83.3	27.7	50.0	36.3	57.2	60.3

Fractional Tube			ISO Tapered Thread(RT)					
T-Tube O.D. (in.)	P-RT Size	Basic Ordering Number	Dimension,mm					
			L	B	C	E	G	F
1/ 4	1/ 8	11102-10104-31102-	31.2	10.4	15.2	4.8	14.3	14.3
1/ 4	1/ 4	11102-10104-31104-	35.8	15.0	15.2	4.8	14.3	19.1
1/ 4	3/ 8	11102-10104-31106-	37.6	15.0	15.2	4.8	14.3	22.2
1/ 4	1/ 2	11102-10104-31108-	42.4	19.8	15.2	4.8	14.3	27.0
3/ 8	1/ 4	11102-10106-31104-	37.6	15.0	16.8	7.1	17.5	19.1
3/ 8	3/ 8	11102-10106-31106-	39.1	15.0	16.8	7.1	17.5	22.2
3/ 8	1/ 2	11102-10106-31108-	43.9	19.8	16.8	7.1	17.5	27.0
1/ 2	1/ 4	11102-10108-31104-	40.4	15.0	22.9	10.4	22.2	20.6
1/ 2	3/ 8	11102-10108-31106-	41.9	15.0	22.9	10.4	22.2	22.2
1/ 2	1/ 2	11102-10108-31108-	46.7	19.8	22.9	10.4	22.2	27.0

Female Connectors

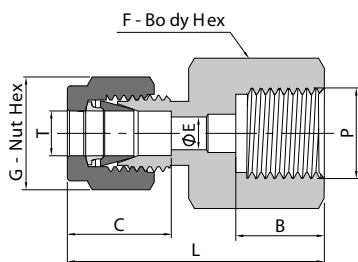

Fractional Tube			ISO Parallel Thread(RG)					
T-Tube O.D. (in.)	P-RG Size	Basic Ordering Number	Dimension,mm					
			L	B	C	E	G	F
1/8	1/4	11102-10102-41104-	35.3	12.9	12.7	2.3	11.1	19.1
1/8	3/8	11102-10102-41106-	38.7	14.2	12.7	2.3	11.1	23.8
1/4	1/4	11102-10104-41104-	37.6	12.9	15.2	4.8	14.3	19.1
1/4	3/8	11102-10104-41106-	37.6	14.2	15.2	4.8	14.3	23.8
1/4	1/2	11102-10104-41108-	43.4	18.8	15.2	4.8	14.3	27.0
5/16	1/4	11102-10105-41104-	38.4	12.9	16.3	5.6	15.9	19.1
5/16	3/8	11102-10105-41106-	39.2	14.2	16.3	6.4	15.9	23.8
5/16	1/2	11102-10105-41108-	40.9	18.8	16.3	7.1	15.9	27.0
3/8	1/4	11102-10106-41104-	39.1	12.9	16.8	5.6	17.5	19.1
3/8	3/8	11102-10106-41106-	38.6	14.2	16.8	6.4	17.5	23.8
3/8	1/2	11102-10106-41108-	41.9	18.8	16.8	7.1	17.5	27.0
1/2	1/4	11102-10108-41104-	41.9	12.9	22.9	5.6	22.2	22.2
1/2	3/8	11102-10108-41106-	44.5	14.2	22.9	6.4	22.2	23.8
1/2	1/2	11102-10108-41108-	48.3	18.8	22.9	7.1	22.2	27.0

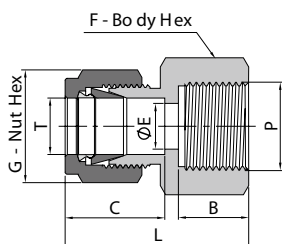

Fractional Tube			Metric Thread					
T-Tube O.D. (in.)	P-Metric Thread Size	Basic Ordering Number	Dimension,mm					
			L	B	C	E	G	F
1/8	M14 x 1.5	11102-10102-51514-	32.30	13	12.70	2.30	11.10	19.10
1/8	M16 x 1.5	11102-10102-51516-	33.30	14	12.70	2.30	11.10	22.20
1/8	M18 x 1.5	11102-10102-51518-	34.30	15	12.70	2.30	11.10	25.40
1/8	M20 x 1.5	11102-10102-51520-	35.30	16	12.70	2.30	11.10	27.00
1/4	M16 x 1.5	11102-10104-51516-	35.80	14	15.20	4.80	14.30	22.20
1/4	M18 x 1.5	11102-10104-51518-	36.80	15	15.20	4.80	14.30	25.40
1/4	M20 x 1.5	11102-10104-51520-	37.80	16	15.20	4.80	14.30	27.00
3/8	M14 x 1.5	11102-10106-51514-	37.10	13	16.80	7.10	17.50	19.10
3/8	M16 x 1.5	11102-10106-51516-	37.50	14	16.80	7.10	17.50	22.20
3/8	M18 x 1.5	11102-10106-51518-	38.50	15	16.80	7.10	17.50	25.40
3/8	M20 x 1.5	11102-10106-51520-	39.50	16	16.80	7.10	17.50	27.00
1/2	M16 x 1.5	11102-10108-51516-	41.40	14	22.90	8.40	22.20	22.20
1/2	M18 x 1.5	11102-10108-51518-	42.40	15	22.90	9.60	22.20	25.40
1/2	M20 x 1.5	11102-10108-51520-	43.40	16	22.90	10.40	22.20	27.00
1/2	M22 x 1.5	11102-10108-51522-	44.40	17	22.90	10.40	22.20	27.00

Female Connectors

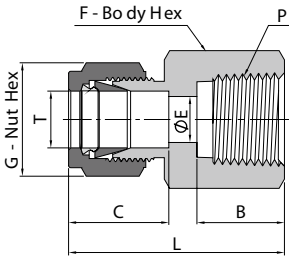

Metric Tube			NPT Thread						
T-Tube O.D. (in.)	P-NPT Size	Basic Ordering Number	Dimension,mm						
			L	B	C	E	G	F	
3	1/8	11102-10203-21102-	28.7	10.4	12.9	2.4	12	14	
3	1/4	11102-10203-21104-	33.5	15.0	12.9	2.4	12	19	
4	1/8	11102-10204-21102-	29.7	10.4	13.7	2.4	12	14	
6	1/8	11102-10206-21102-	31.3	10.4	15.3	4.8	14	14	
6	1/4	11102-10206-21104-	35.8	15.0	15.3	4.8	14	19	
6	3/8	11102-10206-21106-	37.7	15.0	15.3	4.8	14	22	
6	1/2	11102-10206-21108-	42.5	19.8	15.3	4.8	14	27	
8	1/8	11102-10208-21102-	32.1	10.4	16.2	4.8	16	15	
8	1/4	11102-10208-21104-	37.0	15.0	16.2	6.4	16	19	
8	3/8	11102-10208-21106-	38.5	15.0	16.2	6.4	16	22	
8	1/2	11102-10208-21108-	43.3	19.8	16.2	6.4	16	27	
10	1/8	11102-10210-21102-	33.0	10.4	17.2	4.8	19	15	
10	1/4	11102-10210-21104-	37.8	15.0	17.2	7.9	19	19	
10	3/8	11102-10210-21106-	39.4	15.0	17.2	7.9	19	22	
10	1/2	11102-10210-21108-	44.2	19.8	17.2	7.9	19	27	
12	1/4	11102-10212-21104-	40.3	15.0	22.8	7.9	22	22	
12	3/8	11102-10212-21106-	41.9	15.0	22.8	9.5	22	22	
12	1/2	11102-10212-21108-	46.7	19.8	22.8	9.5	22	27	
12	3/4	11102-10212-21112-	49.7	20.6	22.8	9.5	22	35	
14	3/4	11102-10214-21112-	49.7	20.6	24.4	11.1	25	35	
15	1/2	11102-10215-21112-	46.7	19.8	24.4	11.9	25	27	
16	3/8	11102-10216-21106-	41.9	15.0	24.4	9.5	25	27	
16	1/2	11102-10216-21108-	46.9	19.8	24.4	11.9	25	27	
20	1/2	11102-10220-21108-	47.9	19.8	26.0	11.9	32	30	
20	3/4	11102-10220-21112-	49.7	20.6	26.0	15.9	32	35	
22	3/4	11102-10222-21112-	49.7	20.6	26.0	15.9	32	35	
22	1	11102-10222-21116-	57.9	25.4	26.0	18.3	32	41	
25	3/4	11102-10225-21112-	53.4	20.6	31.3	15.9	38	35	
25	1	11102-10225-21116-	62.3	25.4	31.3	21.8	38	41	

Female Connectors

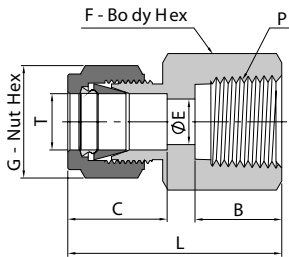

Metric Tube			ISO Tapered Thread(RT)						
T-Tube O.D. (in.)	P-RT Size	Basic Ordering Number	Dimension,mm						
			L	B	C	E	G	F	
3	1/8	11102-10203-31102-	28.7	10.4	12.9	2.4	12	14	
6	1/8	11102-10206-31102-	31.3	10.4	15.3	4.8	14	14	
6	1/4	11102-10206-31104-	35.8	15.0	15.3	4.8	14	19	
6	3/8	11102-10206-31106-	36.9	15.0	15.3	4.8	14	22	
6	1/2	11102-10206-31108-	42.5	19.8	15.3	4.8	14	27	
8	1/8	11102-10208-31102-	32.1	10.4	16.2	6.4	16	15	
8	1/4	11102-10208-31104-	37.0	15.0	16.2	6.4	16	19	
8	3/8	11102-10208-31106-	38.5	15.0	16.2	6.4	16	22	
8	1/2	11102-10208-31108-	43.3	19.8	16.2	6.4	16	27	
10	1/8	11102-10210-31102-	33.0	10.4	17.2	7.9	19	18	
10	1/4	11102-10210-31104-	37.8	15.0	17.2	7.9	19	19	
10	3/8	11102-10210-31106-	39.4	15.0	17.2	7.9	19	22	
10	1/2	11102-10210-31108-	44.2	19.8	17.2	7.9	19	27	
12	1/8	11102-10212-31102-	35.5	10.4	22.8	8.3	22	22	
12	1/4	11102-10212-31104-	40.3	15.0	22.8	9.5	22	22	
12	3/8	11102-10212-31106-	41.9	15.0	22.8	9.5	22	22	
12	1/2	11102-10212-31108-	46.7	19.8	22.8	9.5	22	27	
12	3/4	11102-10212-31112-	49.0	20.6	22.8	9.5	22	35	
15	1/2	11102-10215-31108-	46.7	19.8	24.4	11.9	25	27	
16	1/2	11102-10216-31108-	48.4	19.8	24.4	11.9	25	27	
16	3/4	11102-10216-31112-	49.7	20.6	24.4	12.7	25	35	
20	1/2	11102-10220-31108-	47.9	19.8	26.0	11.9	32	30	
20	3/4	11102-10220-31112-	49.7	20.6	26.0	15.9	32	35	
22	3/4	11102-10222-31112-	49.7	20.6	26.0	15.9	32	35	
22	1	11102-10222-31116-	57.9	25.4	26.0	18.3	32	41	
25	3/4	11102-10225-31112-	53.4	20.6	31.3	15.9	38	35	
25	1	11102-10225-31116-	62.3	25.4	31.3	21.8	38	41	

Female Connectors

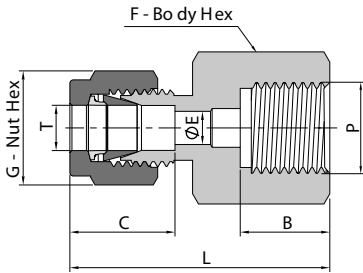

Metric Tube			ISO Parallel Thread(RG)					
T-Tube O.D. (mm)	P-RG Size	Basic Ordering Number	Dimension,mm					
			L	B	C	E	G	F
3	1/4	11102-10203-41104-	35.3	12.9	12.9	2.4	12	19
6	1/4	11102-10206-41104-	37.6	12.9	15.3	4.8	14	19
6	3/8	11102-10206-41106-	37.6	14.2	15.3	4.8	14	24
6	1/2	11102-10206-41108-	43.5	18.8	15.3	4.8	14	27
8	1/4	11102-10208-41104-	38.5	12.9	16.2	6.4	16	19
8	3/8	11102-10208-41106-	36.2	14.2	16.2	6.4	16	24
8	1/2	11102-10208-41108-	41.0	18.8	16.2	6.4	16	27
10	1/4	11102-10210-41104-	39.4	12.9	17.2	5.9	19	19
10	3/8	11102-10210-41106-	38.8	14.2	17.2	7.9	19	24
10	1/2	11102-10210-41108-	42.1	18.8	17.2	7.9	19	27
12	1/4	11102-10212-41104-	41.9	12.9	22.8	5.9	22	22
12	3/8	11102-10212-41106-	44.4	14.2	22.8	7.9	22	24
12	1/2	11102-10212-41108-	48.2	18.8	22.8	9.5	22	27
20	1/2	11102-10220-41108-	54.3	18.8	26.0	11.9	32	30
22	1/2	11102-10222-41108-	54.3	18.8	26.0	11.9	32	30

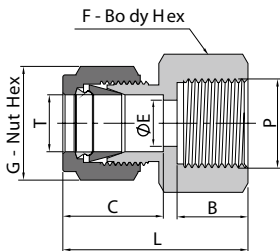

Metric Tube			Metric Thread					
T-Tube O.D. (mm)	P-Metric Thread Size	Basic Ordering Number	Dimension,mm					
			L	B	C	E	G	F
6	M 10 x 1	11102-10206-51510-	32.7	11	15.3	4.0	14	16
6	M 14 x 1.5	11102-10206-51514-	34.7	13	15.3	4.8	14	19
6	M 20 x 1.5	11102-10206-51520-	37.7	16	15.3	4.8	14	27
8	M 8 x 1	11102-10208-51508-	31.6	9	16.2	3.2	16	14
8	M 10 x 1	11102-10208-51510-	33.6	11	16.2	4.0	16	16
8	M 14 x 1.5	11102-10208-51514-	35.6	13	16.2	6.0	16	19
8	M 20 x 1.5	11102-10208-51520-	38.6	16	16.2	6.4	16	27
10	M 16 x 1.5	11102-10210-51516-	38.1	14	17.2	7.9	19	22
12	M 20 x 1.5	11102-10212-51520-	44.9	16	22.8	9.5	22	27
14	M 10 x 1	11102-10214-51510-	42.5	11	24.4	4.0	25	24
14	M 20 x 1.5	11102-10214-51520-	44.9	16	24.4	10.8	25	27
14	M 22 x 1.5	11102-10214-51522-	45.9	17	24.4	11.1	25	27
16	M 20 x 1.5	11102-10216-51520-	44.9	16	24.4	10.8	26	27
20	M 20 x 1.5	11102-10220-51520-	46.5	16	26.0	10.8	32	30
25	M 27 x 2	11102-10225-51527-	54.4	18	31.3	16.1	38	35

Bulkhead Female Connectors

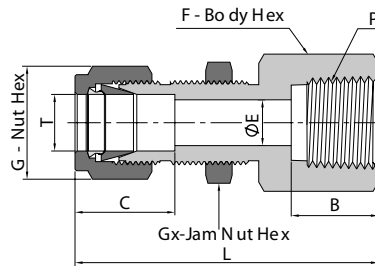

Fractional Tube			NPT Thread									
T-Tube O.D. (in.)	P-NPT Size	Basic Ordering Number	Dimension,mm								Panel Hole Size (mm)	Max. Panel Thickness (mm)
			L	B	C	E	G	F	Gx			
1/16	1/16	11112-10101-21101-	26.2	9.90	8.6	1.3	7.9	11.1	7.9	5.2	3.2	
1/16	1/8	11112-10101-21102-	26.9	10.4	8.6	1.3	7.9	14.3	7.9	5.2	3.2	
1/8	1/8	11112-10102-21102-	44.7	10.4	12.7	2.3	11.1	14.3	12.7	8.3	12.7	
1/8	1/4	11112-10102-21104-	49.6	15.0	12.7	2.3	11.1	19.1	12.7	8.3	12.7	
3/16	1/8	11112-10103-21102-	45.5	10.4	13.7	3.0	12.7	14.3	14.3	9.9	12.7	
1/4	1/8	11112-10104-21102-	47.0	10.4	15.2	4.8	14.3	15.9	15.9	11.5	10.2	
1/4	1/4	11112-10104-21104-	51.8	15.0	15.2	4.8	14.3	19.1	15.9	11.5	10.2	
1/4	3/8	11112-10104-21106-	53.3	15.0	15.2	4.8	14.3	22.2	15.9	11.5	10.2	
1/4	1/2	11112-10104-21108-	58.2	19.8	15.2	4.8	14.3	27.0	15.9	11.5	10.2	
5/16	1/8	11112-10105-21102-	49.8	10.4	16.3	6.4	15.9	14.3	17.5	13.1	11.2	
5/16	1/4	11112-10105-21104-	60.5	15.0	16.3	6.4	15.9	19.1	17.5	13.1	11.2	
3/8	1/8	11112-10106-21102-	50.3	10.4	16.8	7.1	17.5	15.9	19.1	14.5	11.2	
3/8	1/4	11112-10106-21104-	55.1	15.0	16.8	7.1	17.5	19.1	19.1	14.5	11.2	
3/8	3/8	11112-10106-21106-	56.6	15.0	16.8	7.1	17.5	22.2	19.1	14.5	11.2	
3/8	1/2	11112-10106-21108-	61.5	19.8	16.8	7.1	17.5	27.0	19.1	14.5	11.2	
3/8	3/4	11112-10106-21112-	65.3	20.6	16.8	7.1	17.5	33.3	19.1	14.5	11.2	
1/2	1/4	11112-10108-21104-	60.2	15.0	22.9	10.4	22.2	23.8	23.8	19.4	12.7	
1/2	3/8	11112-10108-21106-	61.7	15.0	22.9	10.4	22.2	23.8	23.8	19.4	12.7	
1/2	1/2	11112-10108-21108-	66.5	19.8	22.9	10.4	22.2	27.0	23.8	19.4	12.7	
1/2	3/4	11112-10108-21112-	68.1	20.6	22.9	10.4	22.2	33.3	23.8	19.4	12.7	
5/8	3/8	11112-10110-21106-	62.5	15.0	24.4	12.7	25.4	23.8	27.0	22.6	15.1	
5/8	1/2	11112-10110-21108-	67.3	19.8	24.4	12.7	25.4	27.0	27.0	22.6	15.1	
3/4	1/2	11112-10112-21108-	72.2	19.8	24.4	15.7	28.6	27.0	30.2	25.8	19.8	
3/4	3/4	11112-10112-21112-	73.7	20.6	24.4	15.7	28.6	33.3	30.2	25.8	19.8	
7/8	3/4	11112-10114-21112-	80.8	20.6	25.9	18.3	31.8	33.3	33.3	29.0	23.8	
1	3/4	11112-10116-21112-	84.7	20.6	31.2	22.4	38.1	41.3	41.3	33.7	23.8	
1	1	11112-10116-21116-	93.5	25.4	31.2	22.4	38.1	41.3	41.3	33.7	23.8	

Metric Tube			NPT Thread									
T-Tube O.D. (mm)	P-NPT Size	Basic Ordering Number	Dimension,mm								Panel Hole Size (mm)	Max. Panel Thickness (mm)
			L	B	C	E	G	F	Gx			
6	1/8	11112-10206-21102-	47.2	10.4	15.3	4.8	14	16	16	11.5	10.2	
6	1/4	11112-10206-21104-	51.8	15.0	15.3	4.8	14	19	16	11.5	10.2	
8	1/8	11112-10208-21102-	49.6	10.4	16.2	4.8	16	18	18	13.1	11.2	
10	1/4	11112-10210-21104-	55.2	15.0	17.2	7.9	19	22	22	16.3	11.2	
12	3/8	11112-10212-21106-	60.9	15.0	22.8	9.5	22	24	24	19.5	12.7	
12	1/2	11112-10212-21108-	66.5	19.8	22.8	9.5	22	27	24	19.5	12.7	

Unions

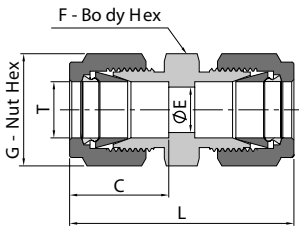

Fractional Tube						
T-Tube O.D. (in.)	Basic Ordering Number	Dimension,mm				
		L	C	G	F	E
1/16	11100-10101-	25.1	8.6	7.9	11.1	1.3
1/8	11100-10102-	35.6	12.7	11.1	11.1	2.3
3/16	11100-10103-	37.3	13.7	12.7	12.7	3.0
1/4	11100-10104-	40.9	15.2	14.3	12.7	4.8
5/16	11100-10105-	42.9	16.2	15.9	14.3	6.4
3/8	11100-10106-	45.0	16.8	17.5	15.9	7.1
1/2	11100-10108-	51.3	22.9	22.2	20.6	10.4
5/8	11100-10110-	52.1	24.4	25.4	23.9	12.7
3/4	11100-10112-	53.6	24.4	28.6	27.0	15.7
7/8	11100-10114-	55.1	25.9	31.8	34.9	18.3
1	11100-10116-	64.8	31.2	38.1	34.9	22.4
1 1/8	11100-10118-	64.8	31.2	44.5	41.3	24.6
1 1/4	11100-10120-	92.2	41.1	47.6	44.5	27.7
1 1/2	11100-10124-	108	50.0	57.2	54.0	34.0

Metric Tube						
T-Tube O.D. (mm)	Basic Ordering Number	Dimension,mm				
		L	C	G	F	E
2	11100-10202-	35.6	12.9	12	12	1.7
3	11100-10203-	35.3	12.9	12	12	2.4
4	11100-10204-	37.3	13.7	12	12	2.4
6	11100-10206-	41.0	15.3	14	14	4.8
8	11100-10208-	43.2	16.2	16	15	6.4
10	11100-10210-	46.2	17.2	19	18	7.9
12	11100-10212-	51.2	22.8	22	22	9.5
14	11100-10214-	52.0	24.4	25	24	11.1
15	11100-10215-	52.0	24.4	25	24	11.9
16	11100-10216-	52.0	24.4	25	24	12.7
18	11100-10218-	53.5	24.4	30	27	15.1
20	11100-10220-	55.0	26.0	32	30	15.9
22	11100-10222-	55.0	26.0	32	30	18.3
25	11100-10225-	65.0	31.3	38	35	21.8
28	11100-10228-	85.0	36.6	46	41	21.8
30	11100-10230-	92.7	39.6	50	46	26.2
32	11100-10232-	97.3	42.0	50	46	28.6
38	11100-10238-	113.6	49.4	60	55	33.7

Conversion Unions

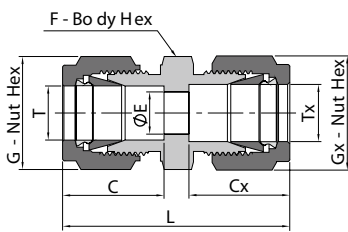

Metric Tube			Fractional Tube							
T-Tube O.D. (mm)	Tx-Tube O.D. (in.)	Basic Ordering Number	Dimension,mm							
			L	C	G	F	E	Cx	Gx	
3	1/8	11104-10203-10102-	35.2	12.9	12	12	2.4	12.7	11.1	
4	1/8	11104-10204-10102-	36.5	13.7	12	12	2.4	12.7	11.1	
4	1/4	11104-10204-10104-	39.4	13.7	12	14	2.4	15.2	14.3	
6	1/8	11104-10206-10102-	38.5	15.3	14	14	2.4	12.7	11.1	
6	1/4	11104-10206-10104-	41.0	15.3	14	14	4.8	15.2	14.3	
6	5/16	11104-10206-10105-	42.3	15.3	14	14	4.8	16.2	15.9	
8	1/4	11104-10208-10104-	42.3	16.2	16	15	4.8	15.2	14.3	
8	3/8	11104-10208-10106-	44.3	16.2	16	16	6.4	16.8	17.5	
10	1/8	11104-10210-10102-	41.8	17.2	19	18	2.4	12.7	11.1	
10	1/4	11104-10210-10104-	44.5	17.2	19	18	4.8	15.2	14.3	
10	5/16	11104-10210-10105-	45.1	17.2	19	18	6.4	16.2	15.9	
10	3/8	11104-10210-10106-	45.9	17.2	19	18	7.1	16.8	17.5	
12	5/16	11104-10212-10105-	47.8	22.8	22	22	6.4	16.2	15.9	
12	3/8	11104-10212-10106-	48.4	22.8	22	22	7.1	16.8	17.5	
12	1/2	11104-10212-10108-	51.2	22.8	22	22	9.5	22.9	22.2	
15	1/2	11104-10215-10108-	52.0	24.4	25	24	10.4	22.9	22.2	
16	5/8	11104-10216-10110-	52.0	24.4	25	24	12.7	24.4	25.4	
18	3/4	11104-10218-10112-	53.5	24.4	30	27	15.1	24.4	28.6	
20	1/2	11104-10220-10108-	55.0	26.0	32	30	10.4	22.9	22.2	
20	1	11104-10220-10116-	62.8	26.0	32	35	15.9	31.2	38.1	
25	1	11104-10225-10116-	65.0	31.3	38	35	21.8	31.2	38.1	

Reducing Unions

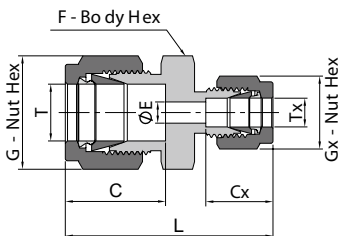

Fractional Tube			Dimension,mm							
T-Tube O.D. (in.)	Tx-Tube O.D. (in.)	Basic Ordering Number	Dimension,mm							
			L	C	G	F	E	Cx	Gx	
1/8	1/16	11103-10102-10101-	31.0	12.7	11.1	11.1	1.3	8.6	7.9	
3/16	1/16	11103-10103-10101-	32.3	13.7	12.7	11.1	1.3	8.6	7.9	
3/16	1/8	11103-10103-10102-	36.6	13.7	12.7	11.1	2.3	12.7	11.1	
1/4	1/16	11103-10104-10101-	34.3	15.2	14.3	12.7	1.3	8.6	7.9	
1/4	1/8	11103-10104-10102-	38.6	15.2	14.3	12.7	2.3	12.7	11.1	
1/4	3/16	11103-10104-10103-	39.4	15.2	14.3	12.7	3.0	13.7	12.7	
5/16	1/8	11103-10105-10102-	39.6	16.2	15.9	14.3	2.3	12.7	11.1	
5/16	1/4	11103-10105-10104-	42.2	16.2	15.9	14.3	4.8	15.2	14.3	
3/8	1/16	11103-10106-10101-	36.6	16.8	17.5	15.9	1.3	8.6	7.9	
3/8	1/8	11103-10106-10102-	40.9	16.8	17.5	15.9	2.3	12.7	11.1	
3/8	1/4	11103-10106-10104-	43.2	16.8	17.5	15.9	4.8	15.2	14.3	
3/8	5/16	11103-10106-10105-	44.2	16.8	17.5	15.9	6.4	16.2	15.9	
1/2	1/8	11103-10108-10102-	45.2	22.8	22.2	20.6	2.3	12.7	11.1	
1/2	1/4	11103-10108-10104-	47.0	22.8	22.2	20.6	4.8	15.2	14.3	
1/2	3/8	11103-10108-10106-	48.5	22.8	22.2	20.6	7.1	16.8	17.5	
5/8	3/8	11103-10110-10106-	49.3	24.4	25.4	23.9	7.1	16.8	17.5	
5/8	1/2	11103-10110-10108-	52.1	24.4	25.4	23.9	10.4	22.8	22.2	
3/4	1/4	11103-10112-10104-	49.3	24.4	28.6	27.0	4.8	15.2	14.3	
3/4	3/8	11103-10112-10106-	50.8	24.4	28.6	27.0	7.1	16.8	17.5	
3/4	1/2	11103-10112-10108-	53.6	24.4	28.6	27.0	10.4	22.8	22.2	
3/4	5/8	11103-10112-10110-	53.6	24.4	28.6	27.0	12.7	24.4	25.4	
1	1/2	11103-10116-10108-	60.5	31.2	38.1	34.9	10.4	22.8	22.2	
1	3/4	11103-10116-10112-	60.5	31.2	38.1	34.9	15.7	24.4	28.6	

Reducing Unions

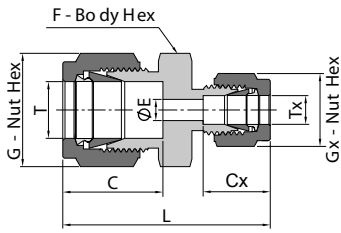

Metric Tube										
T-Tube O.D. (mm)	Tx-Tube O.D. (mm)	Basic Ordering Number	Dimension,mm							
			L	C	G	F	E	Cx	Gx	
3	2	11103-10203-10202-	35.3	12.9	12	12	1.7	12.9	12	
6	2	11103-10206-10202-	38.6	15.3	14	14	1.7	12.9	12	
6	3	11103-10206-10203-	38.6	15.3	14	14	2.4	12.9	12	
6	4	11103-10206-10204-	39.4	15.3	14	14	2.4	13.7	12	
8	6	11103-10208-10206-	42.3	16.3	16	15	4.8	15.3	14	
10	6	11103-10210-10206-	44.5	17.2	19	18	4.8	15.3	14	
10	8	11103-10210-10208-	45.1	17.2	19	18	6.4	16.3	16	
12	6	11103-10212-10206-	47.0	22.8	22	22	4.8	15.3	14	
12	8	11103-10212-10208-	47.8	22.8	22	22	6.4	16.3	16	
12	10	11103-10212-10210-	48.7	22.8	22	22	7.9	17.2	19	
16	10	11103-10216-10210-	49.5	24.4	25	24	7.9	17.2	19	
16	12	11103-10216-10212-	52.0	24.4	25	24	9.5	22.8	22	
18	12	11103-10218-10212-	53.5	24.4	30	27	9.5	22.8	22	
25	18	11103-10225-10218-	61.0	31.3	38	35	15.1	24.4	30	
25	20	11103-10225-10220-	62.3	31.3	38	35	15.9	26.0	32	
30	18	11103-10230-10218-	75.4	39.6	50	46	15.1	24.4	30	
30	20	11103-10230-10220-	75.4	39.6	50	46	15.9	26.0	32	
30	25	11103-10230-10225-	80.1	39.6	50	46	21.8	31.3	38	
32	18	11103-10232-10218-	77.8	42.0	50	46	15.1	24.4	30	
32	20	11103-10232-10220-	77.8	42.0	50	46	15.9	26.0	32	
32	25	11103-10232-10225-	82.3	42.0	50	46	21.8	31.3	38	
38	20	11103-10238-10220-	87.5	49.4	60	55	15.9	26.0	32	
38	25	11103-10238-10225-	92.0	49.4	60	55	21.8	31.3	38	
38	30	11103-10238-10230-	104.6	49.4	60	55	26.2	39.6	50	

Bulkhead Unions

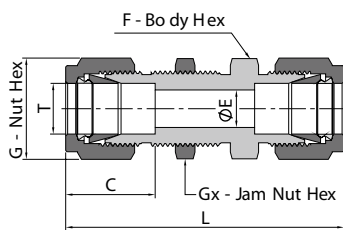

Fractional Tube		Dimension,mm								
Tx-Tube O.D. (in.)	Basic Ordering Number	L	C	E	G	F	Gx	Panel Hole Size (mm)	Max. Panel Thickness (mm)	
1/16	11110-10101-	31.5	8.6	1.3	7.9	7.9	7.9	5.2	3.0	
1/8	11110-10102-	51.3	12.7	2.3	11.1	12.7	12.7	8.3	12.7	
3/16	11110-10103-	53.6	13.7	3.0	12.7	14.3	14.3	9.9	12.7	
1/4	11110-10104-	57.7	15.2	4.8	14.3	15.9	15.9	11.5	10.2	
5/16	11110-10105-	60.7	16.3	6.4	15.9	17.5	17.5	13.1	11.2	
3/8	11110-10106-	62.2	16.8	7.1	17.5	19.1	19.1	14.7	11.2	
1/2	11110-10108-	71.1	22.9	10.4	22.2	23.8	23.8	19.4	12.7	
5/8	11110-10110-	72.6	24.4	12.7	25.4	27.0	27.0	22.6	12.7	
3/4	11110-10112-	79.0	24.4	15.7	28.6	30.2	30.2	25.8	16.8	
7/8	11110-10114-	84.6	25.9	18.3	31.8	34.9	34.9	29.0	19.1	
1	11110-10116-	95.8	31.2	22.4	38.1	41.3	41.3	33.7	19.1	
1 1/4	11110-10120-	123.2	41.1	27.8	47.6	47.6	47.6	41.7	19.1	
1 1/2	11110-10124-	139.2	50.0	34.0	57.2	57.2	57.2	49.6	19.1	

Metric Tube		Dimension,mm								
Tx-Tube O.D. (mm)	Basic Ordering Number	L	C	E	G	F	Gx	Panel Hole Size (mm)	Max. Panel Thickness (mm)	
3	11110-10203-	51.3	12.9	2.4	12	14	14	8.3	12.7	
4	11110-10204-	53.6	13.7	2.4	12	14	14	9.9	12.7	
6	11110-10206-	57.7	15.3	4.8	14	16	16	11.5	10.2	
8	11110-10208-	61.0	16.2	6.4	16	18	18	13.1	11.2	
10	11110-10210-	63.7	17.2	7.9	19	22	22	16.3	11.2	
12	11110-10212-	71.0	22.8	9.5	22	24	24	19.5	12.7	
14	11110-10214-	72.5	24.4	11.1	25	27	27	22.5	12.7	
15	11110-10215-	72.5	24.4	11.9	25	27	27	22.8	12.7	
16	11110-10216-	72.5	24.4	12.7	25	27	27	22.8	12.7	
18	11110-10218-	78.9	24.4	15.1	30	30	30	26.0	16.8	
20	11110-10220-	84.5	26.0	15.9	32	35	35	29.0	19.0	
25	11110-10225-	96.0	31.3	21.8	38	41	41	34.0	19.0	
30	11110-10230-	124.0	39.6	26.2	50	50	50	40.5	19.0	
32	11110-10232-	128.0	42.0	28.6	50	50	50	42.5	19.0	
38	11110-10238-	145.0	49.4	33.7	60	60	60	50.5	19.0	

Bulkhead Reducing Unions

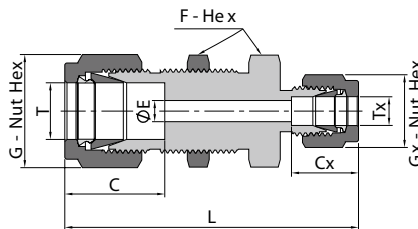

Fractional Tube			Dimension,mm									
T-Tube O.D. (in.)	Tx-Tube O.D. (in.)	Basic Ordering Number	L	C	E	G	F	Cx	Gx	Panel Hole Size (mm)	Max. Panel Thickness (mm)	
1/4	1/8	11113-10104-10102-	55.1	15.2	2.3	14.3	15.9	12.7	11.1	11.5	10.2	
3/8	1/4	11113-10106-10104-	60.7	16.8	4.8	17.5	19.1	15.2	14.3	14.7	11.2	
1/2	1/4	11113-10108-10104-	66.8	22.9	4.8	22.2	23.8	15.2	14.3	19.4	12.7	

Bulkhead Reducing Unions

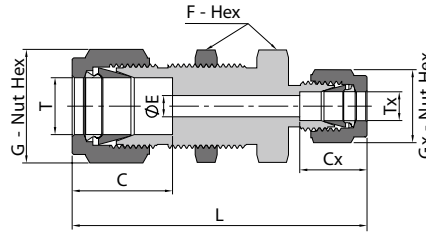

Metric Tube			Dimension,mm									
T-Tube O.D. (mm)	Tx-Tube O.D. (mm)	Basic Ordering Number	L	C	E	G	F	Cx	Gx	Panel Hole Size (mm)	Max. Panel Thickness (mm)	
6	3	111113-10206-10203-	55.10	15.30	2.40	14	16		12	11.50	10.20	
8	6	111113-10208-10206-	60.10	16.20	4.80	16	18		14	13.10	11.20	
12	8	111113-10212-10208-	67.60	22.80	6.40	22	24		16	19.50	12.70	

Bulkhead Conversion Unions

Fractional Tube			Metric Tube									
T-Tube O.D. (in.)	Tx-Tube O.D. (mm)	Basic Ordering Number	L	C	E	G	F	Cx	Gx	Panel Hole Size (mm)	Max. Panel Thickness (mm)	
1/4	6	111114-10104-10206-	57.7	16.8	4.8	14.3	15.9	15.3	14	11.50	10.20	

Metric Tube			Fractional Tube									
T-Tube O.D. (mm)	Tx-Tube O.D. (in.)	Basic Ordering Number	L	C	E	G	F	Cx	Gx	Panel Hole Size (mm)	Max. Panel Thickness (mm)	
6	1/8	111114-10206-10102-	55.10	15.30	2.30	14	16	15.20	11.10	11.50	10.20	
6	1/4	111114-10206-10104-	57.7	15.30	4.80	14	16	16.80	14.30	11.50	11.20	

Bulkhead Locknuts



Fractional Tube		Metric Tube	
T-Tube O.D. (in.)	Basic Ordering Number	T-Tube O.D. (mm)	Basic Ordering Number
1/16	11106-101-	3	11106-203-
1/8	11106-102-	4	11106-204-
3/16	11106-103-	6	11106-206-
1/4	11106-104-	8	11106-208-
5/16	11106-105-	10	11106-210-
3/8	11106-106-	12	11106-212-
1/2	11106-108-	14	11106-214-
5/8	11106-110-	16	11106-216-
3/4	11106-112-	18	11106-218-
7/8	11106-114-	20	11106-220-
1	11106-116-	22	11106-222-
1 1/4	11106-120-	25	11106-225-
1 1/2	11106-124-	28	11106-228-
		30	11106-230-
		32	11106-232-
		38	11106-238-

Male Elbows

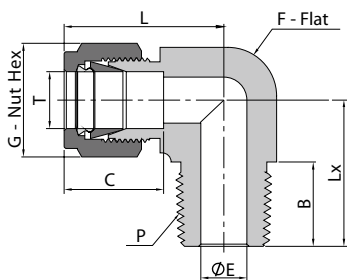

Fractional Tube			NPT Thread							
T-Tube O.D. (in.)	P-NPT Size	Basic Ordering Number	Dimension,mm							
			L	C	G	F	E	B	Lx	
1/16	1/16	11201-10101-20101-	19.1	8.6	7.9	11.1	1.3	9.7	17.8	
1/16	1/8	11201-10101-20102-	19.1	8.6	7.9	11.1	1.3	9.7	17.8	
1/8	1/16	11201-10102-20101-	23.6	12.7	11.1	11.1	2.4	9.7	17.8	
1/8	1/8	11201-10102-20102-	23.6	12.7	11.1	11.1	2.4	9.7	17.8	
1/8	1/4	11201-10102-20104-	24.6	12.7	11.1	12.7	2.4	14.2	23.4	
3/16	1/8	11201-10103-20102-	25.4	13.7	12.7	12.7	3.0	9.7	18.8	
3/16	1/4	11201-10103-20104-	25.4	13.7	12.7	12.7	3.0	14.2	23.4	
1/4	1/16	11201-10104-20101-	26.9	15.2	14.3	12.7	3.0	9.7	18.8	
1/4	1/8	11201-10104-20102-	26.9	15.2	14.3	12.7	4.8	9.7	18.8	
1/4	1/4	11201-10104-20104-	26.9	15.2	14.3	12.7	4.8	14.2	23.4	
1/4	3/8	11201-10104-20106-	29.7	15.2	14.3	17.5	4.8	14.2	26.2	
1/4	1/2	11201-10104-20108-	31.8	15.2	14.3	20.6	4.8	19.1	33.0	
5/16	1/8	11201-10105-20102-	28.7	16.3	15.9	14.3	4.8	9.7	19.8	
5/16	1/4	11201-10105-20104-	28.7	16.3	15.9	14.3	6.4	14.2	24.4	
5/16	3/8	11201-10105-20106-	30.5	16.3	15.9	17.5	6.4	14.2	26.2	
3/8	1/8	11201-10106-20102-	30.5	16.8	17.5	15.9	4.8	9.7	20.8	
3/8	1/4	11201-10106-20104-	30.5	16.8	17.5	15.9	7.1	14.2	25.4	
3/8	3/8	11201-10106-20106-	31.2	16.8	17.5	17.5	7.1	14.2	26.2	
3/8	1/2	11201-10106-20108-	33.3	16.8	17.5	20.6	7.1	19.1	33.0	
3/8	3/4	11201-10106-20112-	37.1	16.8	17.5	27.0	7.1	19.1	36.8	
1/2	1/4	11201-10108-20104-	36.1	22.9	22.2	20.6	7.1	14.2	28.2	
1/2	3/8	11201-10108-20106-	36.1	22.9	22.2	20.6	9.7	14.2	28.2	
1/2	1/2	11201-10108-20108-	36.1	22.9	22.2	20.6	10.4	19.1	33.0	
1/2	3/4	11201-10108-20112-	39.9	22.9	22.2	27.0	10.4	19.1	36.8	
5/8	3/8	11201-10110-20106-	38.1	24.4	25.4	23.8	9.7	14.2	30.2	
5/8	1/2	11201-10110-20108-	38.1	24.4	25.4	23.8	11.9	19.1	35.1	
5/8	3/4	11201-10110-20112-	39.9	24.4	25.4	27.0	12.7	19.1	36.8	
3/4	1/2	11201-10112-20108-	39.9	24.4	28.6	27.0	11.9	19.1	36.8	
3/4	3/4	11201-10112-20112-	39.9	24.4	28.6	27.0	15.7	19.1	36.8	
7/8	3/4	11201-10114-20112-	44.7	25.9	31.8	34.9	15.7	19.1	41.7	
1	3/4	11201-10116-20112-	49.0	31.2	38.1	34.9	15.7	19.1	41.7	
1	1	11201-10116-20116-	49.0	31.2	38.1	34.9	22.4	23.9	46.5	
1 1/4	1 1/4	11201-10120-20120-	66.5	41.1	47.6	42.9	27.7	23.9	47.8	
1 1/2	1 1/2	11201-10124-20124-	78.0	50.0	57.2	50.8	34.0	26.2	60.5	

Fractional Tube			ISO Tapered Thread(RT)							
T-Tube O.D. (in.)	P-RT Size	Basic Ordering Number	Dimension,mm							
			L	C	G	F	E	B	Lx	
1/8	1/8	11201-10102-30102-	23.6	12.7	11.1	11.1	2.4	9.7	17.8	
1/8	1/4	11201-10102-30104-	24.6	12.7	11.1	12.7	2.4	14.2	23.4	
1/4	1/8	11201-10104-30102-	26.9	15.2	14.3	12.7	4.8	9.7	18.8	
1/4	1/4	11201-10104-30104-	26.9	15.2	14.3	12.7	4.8	14.2	23.4	
1/4	3/8	11201-10104-30106-	29.7	15.2	14.3	17.5	4.8	14.2	26.2	
1/4	1/2	11201-10104-30108-	31.8	15.2	14.3	20.6	4.8	19.1	33.0	
5/16	1/4	11201-10105-30104-	28.7	16.3	15.9	14.3	6.4	14.2	24.4	
3/8	1/8	11201-10106-30102-	30.5	16.8	17.5	15.9	4.8	9.7	20.8	
3/8	1/4	11201-10106-30104-	30.5	16.8	17.5	15.9	7.1	14.2	25.4	
3/8	3/8	11201-10106-30106-	31.2	16.8	17.5	17.5	7.1	14.2	26.2	
1/2	3/8	11201-10108-30106-	36.1	22.9	22.2	20.6	9.7	14.2	27.9	
1/2	1/2	11201-10108-30108-	36.1	22.9	22.2	20.6	10.4	19.1	33.0	
3/4	1/2	11201-10112-30108-	39.9	24.4	28.6	27.0	11.9	19.1	36.8	
1	1	11201-10116-30116-	49.0	31.2	38.1	34.9	22.4	23.9	46.5	

Male Elbows

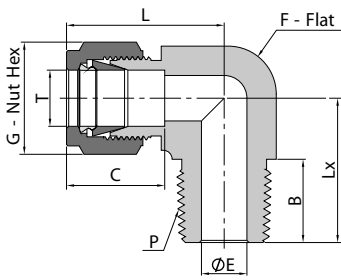

Metric Tube			NPT Thread							
T-Tube O.D. (mm)	P-NPT Size	Basic Ordering Number	Dimension,mm							
			L	C	G	F	E	B	Lx	
3	1/8	11201-10203-20102-	23.6	12.9	12	11.1	2.4	9.7	17.8	
3	1/4	11201-10203-20104-	24.6	12.9	12	12.7	2.4	14.2	23.4	
4	1/8	11201-10204-20102-	25.4	13.7	12	12.7	2.4	9.7	18.8	
4	1/4	11201-10204-20104-	25.4	13.7	12	12.7	2.4	14.2	23.4	
6	1/8	11201-10206-20102-	27.0	15.3	14	12.7	4.8	9.7	18.8	
6	1/4	11201-10206-20104-	27.0	15.3	14	12.7	4.8	14.2	23.4	
6	3/8	11201-10206-20106-	29.8	15.3	14	17.5	4.8	14.2	26.2	
6	1/2	11201-10206-20108-	31.8	15.3	14	20.6	4.8	19.0	33.0	
8	1/8	11201-10208-20102-	28.8	16.2	16	14.3	4.8	9.7	19.8	
8	1/4	11201-10208-20104-	28.8	16.2	16	14.3	6.4	14.2	24.4	
8	3/8	11201-10208-20106-	30.6	16.2	16	17.5	6.4	14.2	26.2	
8	1/2	11201-10208-20108-	32.6	16.2	16	20.6	6.4	19.1	33.0	
10	1/8	11201-10210-20102-	31.5	17.2	19	17.5	4.8	9.7	21.6	
10	1/4	11201-10210-20104-	31.5	17.2	19	17.5	7.1	14.2	26.2	
10	3/8	11201-10210-20106-	31.5	17.2	19	17.5	7.9	14.2	26.2	
10	1/2	11201-10210-20108-	33.5	17.2	19	20.6	7.9	19.1	33.0	
12	1/8	11201-10212-20102-	36.0	22.8	22	20.6	4.8	9.7	23.6	
12	1/4	11201-10212-20104-	36.0	22.8	22	20.6	7.1	14.2	28.2	
12	3/8	11201-10212-20106-	36.0	22.8	22	20.6	9.5	14.2	28.2	
12	1/2	11201-10212-20108-	36.0	22.8	22	20.6	9.5	19.1	33.0	
12	3/4	11201-10212-20112-	39.8	22.8	22	27.0	9.5	19.1	36.8	
15	1/2	11201-10215-20108-	38.0	24.4	25	23.8	11.9	19.1	35.1	
16	1/4	11201-10216-20104-	38.0	24.4	25	23.8	7.1	14.2	30.2	
16	3/8	11201-10216-20106-	38.0	24.4	25	23.8	9.5	14.2	30.2	
16	1/2	11201-10216-20108-	38.0	24.4	25	23.8	11.9	19.1	35.1	
16	3/4	11201-10216-20112-	39.8	24.4	25	27.0	12.7	19.1	36.8	
18	1/2	11201-10218-20108-	39.8	24.4	30	27.0	11.9	19.1	36.8	
18	3/4	11201-10218-20112-	39.8	24.4	30	27.0	15.1	19.1	36.8	
20	1/2	11201-10220-20108-	44.6	26.0	32	34.9	11.9	19.1	41.7	
20	3/4	11201-10220-20112-	44.6	26.0	32	34.9	15.9	19.1	41.7	
22	3/4	11201-10222-20112-	44.6	26.0	32	34.9	15.9	19.1	41.7	
22	1	11201-10222-20116-	44.6	26.0	32	34.9	18.3	23.9	46.5	
25	3/4	11201-10225-20112-	49.1	31.3	38	34.9	15.9	19.0	41.7	
25	1	11201-10225-20116-	49.1	31.3	38	34.9	21.8	23.9	46.5	
30	1 1/4	11201-10230-20120-	69.9	39.6	50	42.9	26.2	23.9	53.1	
32	1 1/4	11201-10232-20120-	72.3	42.0	50	42.9	27.8	23.9	53.1	
38	1 1/2	11201-10238-20124-	84.0	49.4	60	50.8	33.7	26.2	60.4	

Male Elbows

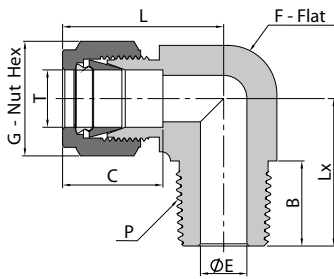

Metric Tube			ISO Tapered Thread(RT)							
T-Tube O.D. (mm)	P-RT Size	Basic Ordering Number	Dimension,mm							
			L	C	G	F	E	B	Lx	
3	1/8	11201-10203-30102-	23.6	12.9	12	11.1	2.4	9.7	17.8	
3	1/4	11201-10203-30104-	24.6	12.9	12	12.7	2.4	14.2	23.4	
4	1/8	11201-10204-30102-	25.4	13.7	12	12.7	2.4	9.7	18.8	
4	1/4	11201-10204-30104-	25.4	13.7	12	12.7	2.4	14.2	23.4	
6	1/8	11201-10206-30102-	27.0	15.3	14	12.7	4.8	9.7	18.8	
6	1/4	11201-10206-30104-	27.0	15.3	14	12.7	4.8	14.2	23.4	
6	3/8	11201-10206-30106-	29.8	15.3	14	17.5	4.8	14.2	26.2	
6	1/2	11201-10206-30108-	31.8	15.3	14	20.6	4.8	19.0	33.0	
8	1/8	11201-10208-30102-	28.8	16.2	16	14.3	4.8	9.7	19.8	
8	1/4	11201-10208-30104-	28.8	16.2	16	14.3	6.4	14.2	24.4	
8	3/8	11201-10208-30106-	30.6	16.2	16	17.5	6.4	14.2	26.2	
8	1/2	11201-10208-30108-	32.6	16.2	16	20.6	6.4	19.1	33.0	
10	1/8	11201-10210-30102-	31.5	17.2	19	17.5	4.8	9.7	21.6	
10	1/4	11201-10210-30104-	31.5	17.2	19	17.5	7.1	14.2	26.2	
10	3/8	11201-10210-30106-	31.5	17.2	19	17.5	7.9	14.2	26.2	
10	1/2	11201-10210-30108-	33.5	17.2	19	20.6	7.9	19.1	33.0	
12	1/8	11201-10212-30102-	36.0	22.8	22	20.6	4.8	9.7	23.6	
12	1/4	11201-10212-30104-	36.0	22.8	22	20.6	7.1	14.2	28.2	
12	3/8	11201-10212-30106-	36.0	22.8	22	20.6	9.5	14.2	28.2	
12	1/2	11201-10212-30108-	36.0	22.8	22	20.6	9.5	19.1	33.0	
12	3/4	11201-10212-30112-	39.8	22.8	22	27.0	9.5	19.1	36.8	
14	1/2	11201-10214-30108-	38.1	24.4	25	23.8	11.1	19.1	35.1	
15	1/2	11201-10215-30108-	38.1	24.4	25	23.8	11.9	19.1	35.1	
16	1/4	11201-10216-30104-	38.0	24.4	25	23.8	7.1	14.2	30.2	
16	3/8	11201-10216-30106-	38.0	24.4	25	23.8	9.5	14.2	30.2	
16	1/2	11201-10216-30108-	38.0	24.4	25	23.8	11.9	19.1	35.1	
16	3/4	11201-10216-30112-	39.8	24.4	25	27.0	12.7	19.1	36.8	
18	1/2	11201-10218-30108-	39.8	24.4	30	27.0	11.9	19.1	36.8	
18	3/4	11201-10218-30112-	39.8	24.4	30	27.0	15.1	19.1	36.8	
20	1/2	11201-10220-30108-	44.6	26.0	32	34.9	11.9	19.1	41.7	
20	3/4	11201-10220-30112-	44.6	26.0	32	34.9	15.9	19.1	41.7	
22	3/4	11201-10222-30112-	44.6	26.0	32	34.9	15.9	19.1	41.7	
22	1	11201-10222-30116-	44.6	26.0	32	34.9	18.3	23.9	46.5	
25	3/4	11201-10225-30112-	49.1	31.3	38	34.9	15.9	19.1	41.7	
25	1	11201-10225-30116-	49.1	31.3	38	34.9	21.8	23.9	46.5	
28	1	11201-10228-30116-	64.0	36.6	46	42.9	21.8	23.9	53.1	

45° Male Elbows

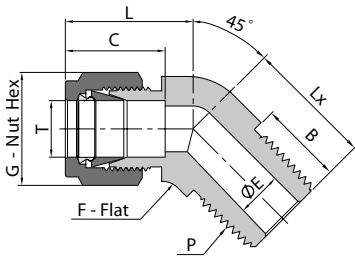

Fractional Tube			NPT Thread							
T-Tube O.D. (in.)	P-NPT Size	Basic Ordering Number	Dimension,mm							
			L	C	G	F	E	B	Lx	
1/16	1/16	11245-10101-20101-	15.7	8.6	7.9	9.5	1.3	9.7	14.5	
1/8	1/8	11245-10102-20102-	20.8	12.7	11.1	11.1	2.3	9.7	16.8	
3/16	1/8	11245-10103-20102-	21.6	13.7	12.7	11.1	3.0	9.7	14.7	
1/4	1/8	11245-10104-20102-	24.6	15.2	14.3	12.7	4.8	9.7	16.5	
1/4	1/4	11245-10104-20104-	24.6	15.2	14.3	12.7	4.8	14.3	21.1	
5/16	1/8	11245-10105-20102-	24.1	16.3	15.9	14.3	4.8	9.7	16.8	
3/8	1/8	11245-10106-20102-	27.9	16.8	17.5	15.9	4.8	9.7	18.3	
3/8	1/4	11245-10106-20104-	27.9	16.8	17.5	15.9	7.1	14.3	22.9	
3/8	3/8	11245-10106-20106-	29.2	16.8	17.5	20.6	7.1	19.1	24.1	
1/2	3/8	11245-10108-20106-	32.0	22.9	22.2	20.6	9.7	19.1	24.1	
5/8	1/2	11245-10110-20108-	30.7	24.4	25.4	23.8	11.9	19.1	29.7	
3/4	3/4	11245-10112-20112-	34.0	24.4	28.6	27.0	15.7	19.1	31.0	
7/8	3/4	11245-10114-20112-	40.4	25.9	31.8	31.8	15.7	19.1	32.3	
1	1	11245-10116-20116-	40.4	31.2	38.1	34.9	22.4	23.9	37.8	

Metric Tube			NPT Thread							
T-Tube O.D. (mm)	P-NPT Size	Basic Ordering Number	Dimension,mm							
			L	C	G	F	E	B	Lx	
6	1/8	11245-10206-20102-	23.4	15.3	14	12.7	4.8	9.7	16.8	
6	1/4	11245-10206-20104-	23.4	15.3	14	12.7	4.8	14.3	21.8	
8	1/8	11245-10208-20102-	24.3	16.2	16	15.9	4.8	9.7	16.8	
10	1/4	11245-10210-20104-	26.6	17.2	19	17.5	7.9	14.3	24.1	
12	3/8	11245-10212-20106-	29.1	22.8	22	20.6	9.5	19.1	24.1	
12	1/2	11245-10212-20108-	30.7	22.8	22	20.6	9.5	19.1	29.7	
16	1/2	11245-10216-20108-	30.7	24.4	25	23.8	11.9	19.1	29.7	

Female Elbows

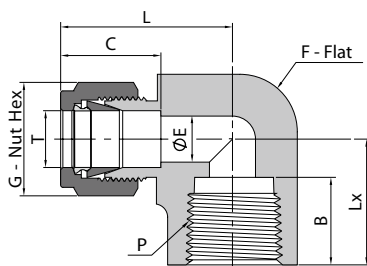

Fractional Tube				NPT Thread						
T-Tube O.D. (in.)	P-NPT Size	Basic Ordering Number	Dimension,mm							
			L	B	C	G	E	F	Lx	
1/16	1/16	11202-10101-31101-	18.0	9.9	8.6	7.9	1.3	11.1	14.2	
1/16	1/8	11202-10101-31102-	20.6	10.4	8.6	7.9	1.3	14.3	19.1	
1/8	1/8	11202-10102-31102-	24.6	10.4	12.7	11.1	2.3	14.3	19.1	
1/8	1/4	11202-10102-31104-	27.4	15.0	12.7	11.1	2.3	17.5	22.4	
3/16	1/8	11202-10103-31102-	25.4	10.4	13.7	12.7	3.0	12.7	19.1	
1/4	1/8	11202-10104-31102-	26.9	10.4	15.2	14.3	4.8	14.3	19.1	
1/4	1/4	11202-10104-31104-	29.7	15.0	15.2	14.3	4.8	17.5	22.4	
1/4	3/8	11202-10104-31106-	31.8	15.0	15.2	14.3	4.8	20.6	22.4	
1/4	1/2	11202-10104-31108-	34.5	19.8	15.2	14.3	4.8	25.4	28.4	
5/16	1/8	11202-10105-31102-	28.7	10.4	16.3	15.9	6.4	14.3	19.1	
5/16	1/4	11202-10105-31104-	30.5	15.0	16.3	15.9	6.4	17.5	22.4	
3/8	1/8	11202-10106-31102-	30.5	10.4	16.8	17.5	7.1	15.9	19.1	
3/8	1/4	11202-10106-31104-	31.2	15.0	16.8	17.5	7.1	17.5	22.4	
3/8	3/8	11202-10106-31106-	33.3	15.0	16.8	17.5	7.1	20.6	22.4	
3/8	1/2	11202-10106-31108-	36.1	19.8	16.8	17.5	7.1	25.4	28.4	
1/2	1/4	11202-10108-31104-	36.1	15.0	22.9	22.2	10.4	20.6	22.4	
1/2	3/8	11202-10108-31106-	36.1	15.0	22.9	22.2	10.4	20.6	22.4	
1/2	1/2	11202-10108-31108-	38.9	19.8	22.9	22.2	10.4	25.4	28.4	
5/8	3/8	11202-10110-31106-	38.1	15.0	24.4	25.4	12.7	23.8	22.4	
5/8	1/2	11202-10110-31108-	39.9	19.8	24.4	25.4	12.7	27.0	28.4	
3/4	1/2	11202-10112-31108-	39.9	19.8	24.4	28.6	15.7	27.0	28.4	
3/4	3/4	11202-10112-31112-	44.7	20.6	24.4	28.6	15.7	34.9	31.8	
7/8	3/4	11202-10114-31112-	44.7	20.6	25.9	31.8	18.3	34.9	31.8	
1	3/4	11202-10116-31112-	49.0	20.6	31.2	38.1	22.4	34.9	31.8	
1	1	11202-10116-31116-	53.6	25.4	31.2	38.1	22.4	42.9	38.1	

Metric Tube				NPT Thread						
T-Tube O.D. (mm)	P-NPT Size	Basic Ordering Number	Dimension,mm							
			L	B	C	G	E	F	Lx	
6	1/8	11202-10206-31102-	27.0	10.4	15.3	14	4.8	12.7	19.0	
6	1/4	11202-10206-31104-	29.8	15.0	15.3	14	4.8	17.5	22.4	
8	1/8	11202-10208-31102-	28.8	10.4	16.2	16	4.8	14.3	19.1	
8	1/4	11202-10208-31104-	30.6	15.0	16.2	16	6.4	17.5	22.4	
10	1/4	11202-10210-31104-	33.5	15.0	17.2	19	7.9	20.6	22.4	
10	3/8	11202-10210-31106-	33.5	15.0	17.2	19	7.9	20.6	22.4	
10	1/2	11202-10210-31108-	36.6	19.8	17.2	19	7.9	25.4	28.5	
12	1/4	11202-10212-31104-	36.0	15.0	22.8	22	7.9	20.6	22.4	
12	3/8	11202-10212-31106-	36.0	15.0	22.8	22	9.5	20.6	22.4	
12	1/2	11202-10212-31108-	38.8	19.8	22.8	22	9.5	25.4	28.4	
16	3/8	11202-10216-31106-	39.5	15.0	24.4	25	9.5	27.0	23.6	
16	1/2	11202-10216-31108-	39.5	19.8	24.4	25	12.7	27.0	28.5	

Union Elbows

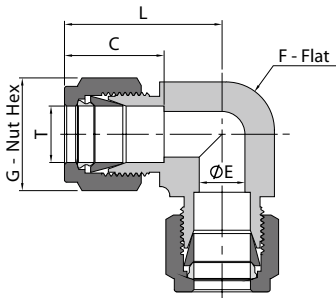

Fractional Tube						
T-Tube O.D. (in.)	Basic Ordering Number	Dimension,mm				
		L	C	G	F	E
1/16	11200-10101-	17.8	8.6	7.9	9.5	1.3
1/8	11200-10102-	22.4	12.7	11.1	9.5	2.3
3/16	11200-10103-	25.4	13.7	12.7	12.7	3.0
1/4	11200-10104-	26.9	15.2	14.3	12.7	4.8
5/16	11200-10105-	28.7	16.3	15.9	14.3	6.4
3/8	11200-10106-	30.5	16.8	17.5	15.9	7.1
1/2	11200-10108-	36.1	22.9	22.2	20.6	10.4
5/8	11200-10110-	38.1	24.4	25.4	23.8	12.7
3/4	11200-10112-	39.9	24.4	28.6	27.0	15.7
7/8	11200-10114-	44.7	25.9	31.8	34.9	18.3
1	11200-10116-	49.0	31.2	38.1	34.9	22.4
1 1/8	11200-10118-	55.1	31.2	41.3	42.9	24.6
1 1/4	11200-10120-	66.5	41.1	47.6	42.9	27.7
1 1/2	11200-10124-	78.0	50.0	57.2	50.8	34.0

Metric Tube						
T-Tube O.D. (mm)	Basic Ordering Number	Dimension,mm				
		L	C	G	F	E
3	11200-10203-	22.3	12.9	12	9.5	2.4
4	11200-10204-	25.4	13.7	12	12.7	2.4
6	11200-10206-	27.0	15.3	14	12.7	4.8
8	11200-10208-	28.8	16.2	16	14.3	6.4
10	11200-10210-	31.5	17.2	19	17.5	7.9
12	11200-10212-	36.0	22.8	22	20.6	9.5
14	11200-10214-	38.0	24.4	25	23.8	11.0
15	11200-10215-	38.8	24.4	25	23.8	11.9
16	11200-10216-	38.0	24.4	25	23.8	12.7
18	11200-10218-	39.8	24.4	30	27.0	15.1
20	11200-10220-	44.6	26.0	32	34.9	15.9
22	11200-10222-	44.6	26.0	32	34.9	18.3
25	11200-10225-	49.1	31.3	38	34.9	21.8
28	11200-10228-	64.0	36.6	46	42.9	21.8
30	11200-10230-	69.9	39.6	50	42.9	26.2
32	11200-10232-	72.3	42.0	50	42.9	28.6
38	11200-10238-	84.0	49.4	60	50.8	33.7

Union Reducing Elbows

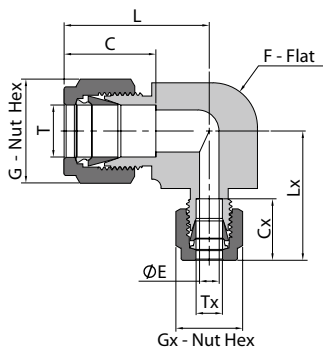

Fractional Tube			Dimension,mm									
T-Tube O.D. (in.)	Tx-Tube O.D. (in.)	Basic Ordering Number	L	C	G	F	E	Cx	Gx	Lx		
3/16	1/8	11203-10103-10102-	25.4	13.7	12.7	12.7	2.3	12.7	11.1	24.7		
1/4	1/8	11203-10104-10102-	26.9	15.2	14.3	12.7	2.3	12.7	11.1	25.4		
5/16	1/8	11203-10105-10102-	29.7	16.3	15.9	14.3	2.3	12.7	11.1	26.4		
5/16	1/4	11203-10105-10104-	29.7	16.3	15.9	14.3	4.8	15.2	14.3	29.0		
3/8	1/8	11203-10106-10102-	30.5	16.8	17.5	15.9	2.3	12.7	11.1	26.4		
3/8	1/4	11203-10106-10104-	30.5	16.8	17.5	15.9	4.8	15.2	14.3	29.0		
3/8	5/16	11203-10106-10105-	30.5	16.8	17.5	15.9	6.4	16.3	15.9	29.7		
1/2	1/4	11203-10108-10104-	36.1	22.9	22.2	20.6	4.8	15.2	14.3	32.2		
1/2	5/16	11203-10108-10105-	36.1	22.9	22.2	20.6	6.4	16.3	15.9	32.5		
1/2	3/8	11203-10108-10106-	36.1	22.9	22.2	20.6	7.1	16.8	17.5	33.6		
5/8	3/8	11203-10110-10106-	38.1	24.4	25.4	23.8	7.1	16.8	17.5	35.6		
5/8	1/2	11203-10110-10108-	38.1	24.4	25.4	23.8	10.4	22.9	22.2	38.1		
3/4	1/4	11203-10112-10104-	39.9	24.4	28.6	27.0	4.8	15.2	14.3	35.9		
3/4	3/8	11203-10112-10106-	39.9	24.4	28.6	27.0	7.1	16.8	17.5	37.4		
3/4	1/2	11203-10112-10108-	39.9	24.4	28.6	27.0	10.4	22.9	22.2	39.9		
7/8	1/4	11203-10114-10104-	44.7	25.9	31.8	34.9	4.8	15.2	14.3	40.7		
1	1/2	11203-10116-10108-	49.0	31.2	38.1	34.9	10.4	22.9	22.2	44.4		
1	3/4	11203-10116-10112-	49.0	31.2	38.1	34.9	15.7	24.4	28.6	44.4		

Metric Tube			Dimension,mm									
T-Tube O.D. (mm)	Tx-Tube O.D. (mm)	Basic Ordering Number	L	C	G	F	E	Cx	Gx	Lx		
8	6	11203-10208-10206-	28.8	16.2	16	14.3	4.8	15.3	14	27.9		
10	8	11203-10210-10208-	31.5	17.2	19	17.5	6.4	16.2	16	30.5		
12	8	11203-10212-10208-	36.0	22.8	22	20.6	6.4	16.2	16	32.6		
14	8	11203-10214-10208-	38.8	24.4	25	23.8	6.4	16.2	16	35.4		
14	10	11203-10214-10210-	38.8	24.4	25	23.8	7.9	17.2	19	36.4		

Male Branch Tees

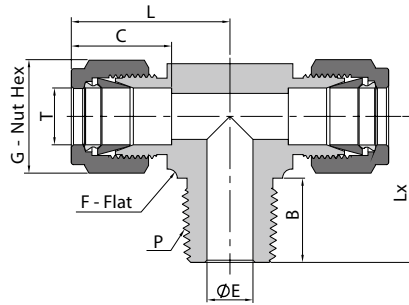

Fractional Tube			NPT Thread						
T-Tube O.D. (in.)	P-NPT Size	Basic Ordering Number	Dimension,mm						
			L	C	G	F	E	B	Lx
1/8	1/8	11301-10102-20102-	23.6	12.7	11.1	11.1	2.3	9.7	17.8
1/8	1/4	11301-10102-20104-	24.6	12.7	11.1	12.7	2.3	14.2	23.4
3/16	1/8	11301-10103-20102-	24.4	13.7	12.7	11.1	3.0	9.7	17.8
1/4	1/8	11301-10104-20102-	26.9	15.2	14.3	12.7	4.8	9.7	18.8
1/4	1/4	11301-10104-20104-	26.9	15.2	14.3	12.7	4.8	14.2	23.4
5/16	1/8	11301-10105-20102-	29.7	16.3	15.9	15.9	4.8	9.7	20.8
5/16	1/4	11301-10105-20104-	29.7	16.3	15.9	15.9	6.4	14.2	25.7
3/8	1/4	11301-10106-20104-	30.5	16.8	17.5	15.9	7.1	14.2	25.4
3/8	3/8	11301-10106-20106-	33.3	16.8	17.5	20.6	7.1	14.2	28.2
1/2	3/8	11301-10108-20106-	36.1	22.9	22.2	20.6	9.7	14.2	28.2
1/2	1/2	11301-10108-20108-	36.1	22.9	22.2	20.6	10.4	19.1	33.0
5/8	1/2	11301-10110-20108-	38.9	24.4	25.4	25.4	11.9	19.1	35.8
3/4	3/4	11301-10112-20112-	39.9	24.4	28.6	27.0	15.7	19.1	36.8
7/8	3/4	11301-10114-20112-	44.7	25.9	31.8	33.3	15.7	19.1	38.1
1	3/4	11301-10116-20112-	49.3	31.2	38.1	33.3	15.7	19.1	42.2
1	1	11301-10116-20116-	49.3	31.2	38.1	34.9	22.4	23.9	46.7

Metric Tube			NPT Thread						
T-Tube O.D. (mm)	P-NPT Size	Basic Ordering Number	Dimension,mm						
			L	C	G	F	E	B	Lx
6	1/8	11301-10206-20102-	27.0	15.3	14	12.7	4.8	9.7	18.8
6	1/4	11301-10206-20104-	27.0	15.3	14	12.7	4.8	14.2	23.4
8	1/8	11301-10208-20102-	29.9	16.2	16	15.9	4.8	9.7	20.8
8	1/4	11301-10208-20104-	29.9	16.2	16	15.9	6.4	14.2	25.4
10	1/4	11301-10210-20104-	33.5	17.2	19	20.6	7.9	14.2	28.2
10	3/8	11301-10210-20106-	33.5	17.2	19	20.6	7.9	14.2	28.2
12	1/4	11301-10212-20104-	36.0	22.8	22	20.6	7.9	14.2	28.2
12	3/8	11301-10212-20106-	36.0	22.8	22	20.6	9.5	14.2	28.2
12	1/2	11301-10212-20108-	36.0	22.8	22	20.6	9.5	19.1	33.0
16	1/2	11301-10216-20108-	38.8	24.4	25	25.4	11.9	19.1	35.8

Male Run Tees

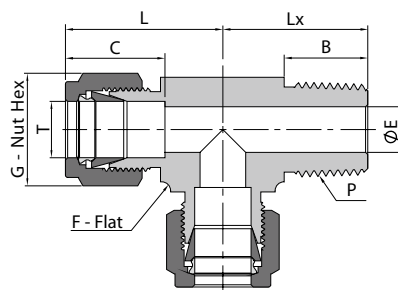

Fractional Tube			NPT Thread							
T-Tube O.D. (in.)	P-NPT Size	Basic Ordering Number	Dimension,mm							
			L	C	G	F	E	B	Lx	
1/8	1/8	11311-10102-20102-	23.6	12.7	11.1	11.1	2.3	9.7	17.8	
1/8	1/4	11311-10102-20104-	24.6	12.7	11.1	12.7	2.3	14.2	23.4	
3/16	1/8	11311-10103-20102-	24.4	13.7	12.7	11.1	3.0	9.7	17.8	
1/4	1/8	11311-10104-20102-	26.9	15.2	14.3	12.7	4.8	9.7	18.8	
1/4	1/4	11311-10104-20104-	26.9	15.2	14.3	12.7	4.8	14.2	23.4	
5/16	1/8	11311-10105-20102-	29.7	16.3	15.9	15.9	4.8	9.7	20.8	
5/16	1/4	11311-10105-20104-	29.7	16.3	15.9	15.9	6.4	14.2	25.7	
3/8	1/4	11311-10106-20104-	30.5	16.8	17.5	15.9	7.1	14.2	25.4	
3/8	3/8	11311-10106-20106-	33.3	16.8	17.5	20.6	7.1	14.2	28.2	
1/2	3/8	11311-10108-20106-	36.1	22.9	22.2	20.6	9.7	14.2	28.2	
1/2	1/2	11311-10108-20108-	36.1	22.9	22.2	20.6	10.4	19.1	33.0	
5/8	1/2	11311-10110-20108-	38.1	24.4	25.4	23.8	11.9	19.1	35.8	
3/4	3/4	11311-10112-20112-	39.9	24.4	28.6	27.0	15.7	19.1	36.8	
7/8	3/4	11311-10114-20112-	44.7	25.9	31.8	33.3	15.7	19.1	38.1	
1	3/4	11311-10116-20112-	49.3	31.2	38.1	33.3	15.7	19.1	42.2	
1	1	11311-10116-20116-	49.3	31.2	38.1	34.9	22.4	23.9	46.7	

Metric Tube			NPT Thread							
T-Tube O.D. (mm)	P-NPT Size	Basic Ordering Number	Dimension,mm							
			L	C	G	F	E	B	Lx	
6	1/8	11311-10206-20102-	27.0	15.3	14	12.7	4.8	9.7	18.0	
6	1/4	11311-10206-20104-	27.0	15.3	14	12.7	4.8	14.2	23.4	
8	1/8	11311-10208-20102-	29.9	16.2	16	15.9	4.8	9.7	20.8	
8	1/4	11311-10208-20104-	29.9	16.2	16	15.9	6.4	14.2	25.4	
10	1/4	11311-10210-20104-	33.5	17.2	19	20.6	7.9	14.2	28.2	
10	1/2	11311-10210-20108-	33.5	17.2	19	20.6	7.9	14.2	28.2	
12	1/4	11311-10212-20104-	36.0	22.8	22	20.6	7.9	14.2	28.2	
12	3/8	11311-10212-20106-	36.0	22.8	22	20.6	9.5	14.2	28.2	
12	1/2	11311-10212-20108-	36.0	22.8	22	20.6	9.5	19.1	33.0	
16	1/2	11311-10216-20108-	38.0	24.4	25	23.8	11.9	19.1	35.0	

Female Branch Tees

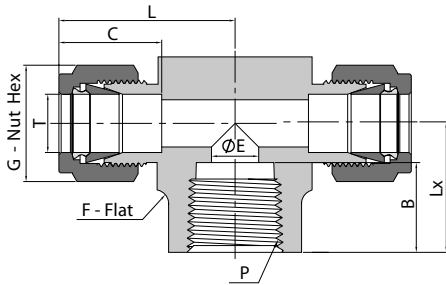

Fractional Tube			NPT Thread							
T-Tube O.D. (in.)	P-NPT Size	Basic Ordering Number	Dimension,mm							
			L	C	G	F	E	B	Lx	
1/8	1/8	11302-10102-21102-	24.6	12.7	11.1	12.7	2.3	10.4	19.1	
3/16	1/8	11302-10103-21102-	25.7	13.7	12.7	12.7	3.0	10.4	19.1	
1/4	1/8	11302-10104-21102-	26.9	15.2	14.3	12.7	4.8	10.4	19.1	
1/4	1/4	11302-10104-21104-	29.7	15.2	14.3	17.5	4.8	15.0	22.4	
5/16	1/8	11302-10105-21102-	29.7	16.2	15.9	15.9	6.4	10.4	19.1	
3/8	1/4	11302-10106-21104-	31.2	16.8	17.5	17.5	7.1	15.0	22.4	
3/8	3/8	11302-10106-21106-	33.3	16.8	17.5	20.6	7.1	15.0	22.4	
3/8	1/2	11302-10106-21108-	36.1	16.8	17.5	25.4	7.1	19.8	28.4	
1/2	1/4	11302-10108-21104-	36.1	22.9	22.2	20.6	10.4	15.0	22.4	
1/2	3/8	11302-10108-21106-	36.1	22.9	22.2	20.6	10.4	15.0	22.4	
1/2	1/2	11302-10108-21108-	38.9	22.9	22.2	25.4	10.4	19.8	28.4	
5/8	1/2	11302-10110-21108-	38.9	24.4	25.4	25.4	12.7	19.8	28.4	
3/4	3/4	11302-10112-21112-	44.7	24.4	28.6	34.9	15.7	20.6	31.8	
7/8	3/4	11302-10114-21112-	44.7	25.9	31.8	34.9	18.3	20.6	31.8	
1	3/4	11302-10116-21112-	49.0	31.2	38.1	34.9	22.4	20.6	31.8	
1	1	11302-10116-21116-	53.6	31.2	38.1	42.9	22.4	25.4	38.1	

Metric Tube			NPT Thread							
T-Tube O.D. (mm)	P-NPT Size	Basic Ordering Number	Dimension,mm							
			L	C	G	F	E	B	Lx	
6	1/8	11302-10206-21102-	27.0	15.3	14	12.7	4.8	10.4	19.0	
6	1/4	11302-10206-21104-	29.8	15.3	14	17.5	4.8	15.0	22.4	
8	1/8	11302-10208-21102-	29.9	16.2	16	15.9	6.4	10.4	19.0	
8	1/4	11302-10208-21104-	30.6	16.2	16	17.5	6.4	15.0	22.4	
10	1/4	11302-10210-21104-	33.5	17.2	19	20.6	7.9	15.0	22.4	
12	1/8	11302-10212-21102-	36.0	22.8	22	20.6	6.4	10.4	22.3	
12	1/4	11302-10212-21104-	36.0	22.8	22	20.6	9.5	15.0	22.4	
12	3/8	11302-10212-21106-	36.0	22.8	22	20.6	9.5	15.0	22.4	
12	1/2	11302-10212-21108-	38.8	22.8	22	25.4	9.5	19.8	28.5	
16	1/2	11302-10216-21108-	38.8	24.4	25	25.4	12.7	19.8	28.4	

Female Run Tees

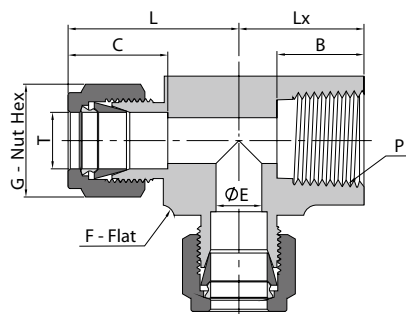

Fractional Tube			NPT Thread							
T-Tube O.D. (in.)	P-NPT Size	Basic Ordering Number	Dimension,mm							
			L	C	G	F	E	B	Lx	
1/8	1/8	11322-10102-21102-	24.6	12.7	11.1	12.7	2.3	10.4	19.1	
3/16	1/8	11322-10103-21102-	25.7	13.7	12.7	12.7	3.0	10.4	19.1	
1/4	1/8	11322-10104-21102-	26.9	15.2	14.3	12.7	4.8	10.4	19.1	
1/4	1/4	11322-10104-21104-	29.7	15.2	14.3	17.5	4.8	15.0	22.4	
5/16	1/8	11322-10105-21102-	29.7	16.2	15.9	15.9	6.4	10.4	19.1	
3/8	1/4	11322-10106-21104-	31.2	16.8	17.5	17.5	7.1	15.0	22.4	
1/2	1/4	11322-10108-21104-	36.1	22.9	22.2	20.6	10.4	15.0	22.4	
1/2	3/8	11322-10108-21106-	36.1	22.9	22.2	20.6	10.4	15.0	22.4	
1/2	1/2	11322-10108-21108-	39.9	22.9	22.2	27.0	10.4	19.8	28.4	
5/8	1/2	11322-10110-21108-	39.9	24.4	25.4	27.0	12.7	19.8	28.4	
3/4	3/4	11322-10112-21112-	44.7	24.4	28.6	34.9	15.7	20.6	31.8	
7/8	1/2	11322-10114-21108-	44.7	25.9	31.8	34.9	15.7	19.8	28.4	
7/8	3/4	11322-10114-21112-	44.7	25.9	31.8	34.9	18.3	20.6	31.8	
1	3/4	11322-10116-21112-	49.0	31.2	38.1	34.9	22.4	20.6	31.8	
1	1	11322-10116-21116-	53.6	31.2	38.1	42.9	22.4	25.4	38.1	

Metric Tube			NPT Thread							
T-Tube O.D. (mm)	P-NPT Size	Basic Ordering Number	Dimension,mm							
			L	C	G	F	E	B	Lx	
6	1/8	11322-10206-21102-	27.0	15.3	14	12.7	4.8	10.4	19.0	
6	1/4	11322-10206-21104-	29.8	15.3	14	17.5	4.8	15.0	22.4	
8	1/8	11322-10208-21102-	29.9	16.2	16	15.9	4.8	10.4	19.0	
8	1/4	11322-10208-21104-	30.6	16.2	16	17.5	6.4	15.0	22.4	
10	1/4	11322-10210-21104-	33.5	17.2	19	20.6	7.9	15.0	22.4	
12	1/4	11322-10212-21104-	36.0	22.8	22	20.6	9.5	15.0	22.4	
12	3/8	11322-10212-21106-	36.0	22.8	22	20.6	9.5	15.0	23.1	
12	1/2	11322-10212-21108-	38.8	22.8	22	25.4	9.5	19.8	28.5	
16	1/2	11322-10216-21108-	39.8	24.4	25	27.0	11.9	19.8	28.4	

Union Tees

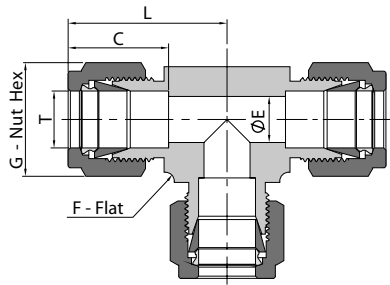

Fractional Tube

T-Tube O.D. (in.)	Basic Ordering Number	Dimension,mm				
		L	C	G	F	E
1/16	11300-10101-	17.8	8.6	7.9	9.5	1.3
1/8	11300-10102-	22.4	12.7	11.1	9.5	2.3
3/16	11300-10103-	24.4	13.7	12.7	11.1	3.0
1/4	11300-10104-	26.9	15.2	14.3	12.7	4.8
5/16	11300-10105-	29.7	16.2	15.9	15.9	6.4
3/8	11300-10106-	30.5	16.8	17.5	15.9	7.1
1/2	11300-10108-	36.1	22.9	22.2	20.6	10.4
5/8	11300-10110-	38.9	24.4	25.4	25.4	12.7
3/4	11300-10112-	39.9	24.4	28.6	27.0	15.7
7/8	11300-10114-	44.7	25.9	31.8	34.9	18.3
1	11300-10116-	49.0	31.2	38.1	34.9	22.4
1 1/8	11300-10118-	55.1	31.2	46.0	42.9	24.6
1 1/4	11300-10120-	66.5	41.1	47.6	42.9	27.7
1 1/2	11300-10124-	78.0	50.0	57.2	50.8	34.0

Metric Tube

T-Tube O.D. (mm)	Basic Ordering Number	Dimension,mm				
		L	C	G	F	E
2	11300-10202-	22.3	12.9	12	9.5	1.7
3	11300-10203-	22.3	12.9	12	9.5	2.4
4	11300-10204-	25.4	13.7	12	12.7	2.4
6	11300-10206-	27.0	15.3	14	12.7	4.8
8	11300-10208-	29.9	16.2	16	15.9	6.4
10	11300-10210-	31.5	17.2	19	17.5	7.9
12	11300-10212-	36.0	22.8	22	20.6	9.5
14	11300-10214-	38.8	24.4	25	25.4	11.1
15	11300-10215-	38.8	24.4	25	25.4	11.9
16	11300-10216-	38.8	24.4	25	25.4	12.7
18	11300-10218-	38.8	24.4	30	27.0	15.1
20	11300-10220-	44.6	26.0	32	34.9	15.9
22	11300-10222-	44.6	26.0	32	34.9	18.3
25	11300-10225-	49.1	31.3	38	34.9	21.8
28	11300-10228-	64.0	36.6	46	42.9	21.8
30	11300-10230-	69.9	39.6	50	42.9	26.2
32	11300-10232-	72.3	42.0	50	42.9	28.6
38	11300-10238-	84.0	49.4	60	50.8	33.7

Reducing Union Tees

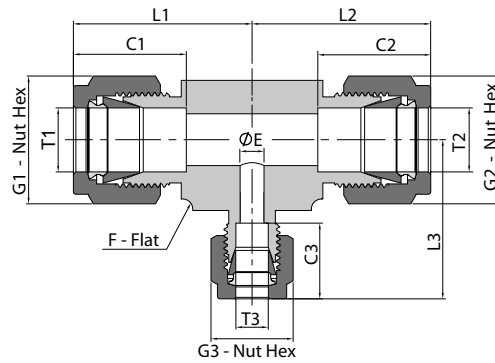

Fractional Tube				Dimension,mm										
T1-Tube O.D. (in.)	T2-Tube O.D. (in.)	T3-Tube O.D. (in.)	Basic Ordering Number	L1	L2	L3	C1	C2	C3	G1	G2	G3	F	E
1/4	1/4	1/8	11303-10104-10104-10102-	26.7	26.7	24.4	15.2	15.2	12.7	14.3	14.3	11.1	12.7	2.3
3/8	1/4	1/4	11303-10106-10104-10104-	30.5	29.0	29.0	16.8	15.2	15.2	17.5	14.3	14.3	15.9	4.8
3/8	1/4	3/8	11303-10106-10104-10106-	30.5	29.0	30.5	16.8	15.2	16.8	17.5	14.3	17.5	15.9	4.8
3/8	3/8	1/4	11303-10106-10106-10104-	30.5	30.5	29.0	16.8	16.8	15.2	17.5	17.5	14.3	15.9	4.8
1/2	1/4	1/4	11303-10108-10104-10104-	36.1	31.8	31.8	22.9	15.2	15.2	22.2	14.3	14.3	20.6	4.8
1/2	1/4	1/2	11303-10108-10104-10108-	36.1	31.8	36.1	22.9	15.2	22.9	22.2	14.3	22.2	20.6	4.8
1/2	3/8	3/8	11303-10108-10106-10106-	36.1	33.3	33.3	22.9	16.8	16.8	22.2	17.5	17.5	20.6	7.1
1/2	3/8	1/2	11303-10108-10106-10108-	36.1	33.3	36.1	22.9	16.8	22.9	22.2	17.5	22.2	20.6	7.1
1/2	1/2	1/4	11303-10108-10108-10104-	36.1	36.1	31.8	22.9	22.9	15.2	22.2	22.2	14.3	20.6	4.8
1/2	1/2	3/8	11303-10108-10108-10106-	36.1	36.1	33.3	22.9	22.9	16.8	22.2	22.2	17.5	20.6	7.1
5/8	3/8	3/8	11303-10110-10106-10106-	38.9	36.1	36.1	24.4	16.8	16.8	25.4	17.5	17.5	25.4	7.1
5/8	3/8	1/2	11303-10110-10106-10108-	38.9	36.1	38.9	24.4	16.8	22.9	25.4	17.5	22.2	25.4	7.1
5/8	1/2	3/8	11303-10110-10108-10106-	38.9	38.9	36.1	24.4	22.9	16.8	25.4	22.2	17.5	25.4	7.1
5/8	1/2	1/2	11303-10110-10108-10108-	38.9	38.9	38.9	24.4	22.9	22.9	25.4	22.2	22.2	25.4	10.4
5/8	5/8	3/8	11303-10110-10110-10106-	38.9	38.9	36.1	24.4	24.4	16.8	25.4	25.4	17.5	25.4	7.1
5/8	5/8	1/2	11303-10110-10110-10108-	38.9	38.9	38.9	24.4	24.4	22.9	25.4	25.4	22.2	25.4	10.4
3/4	3/8	3/8	11303-10112-10106-10106-	39.6	36.9	36.9	24.4	16.8	16.8	28.6	17.5	17.5	27.0	7.1
3/4	1/2	3/8	11303-10112-10108-10106-	39.6	39.6	36.9	24.4	22.9	16.8	28.6	22.2	17.5	27.0	7.1
3/4	1/2	1/2	11303-10112-10108-10108-	39.6	39.6	39.6	24.4	22.9	22.9	28.6	22.2	22.2	27.0	10.4
3/4	5/8	3/8	11303-10112-10110-10106-	39.6	39.6	36.9	24.4	24.4	16.8	28.6	25.4	17.5	27.0	7.1
3/4	5/8	1/2	11303-10112-10110-10108-	39.6	39.6	39.6	24.4	24.4	22.9	28.6	25.4	22.2	27.0	10.4
3/4	5/8	5/8	11303-10112-10110-10110-	39.6	39.6	39.6	24.4	24.4	24.4	28.6	25.4	25.4	27.0	12.7
3/4	3/4	1/4	11303-10112-10112-10104-	39.6	39.6	35.1	24.4	24.4	15.2	28.6	28.6	14.3	27.0	4.8
3/4	3/4	3/8	11303-10112-10112-10106-	39.6	39.6	36.9	24.4	24.4	16.8	28.6	28.6	17.5	27.0	7.1
3/4	3/4	1/2	11303-10112-10112-10108-	39.6	39.6	39.6	24.4	24.4	22.9	28.6	28.6	22.2	27.0	10.4
3/4	3/4	5/8	11303-10112-10112-10110-	39.6	39.6	39.6	24.4	24.4	24.4	28.6	28.6	25.4	27.0	12.7
1	3/8	3/8	11303-10116-10106-10106-	49.3	41.9	41.9	31.2	16.8	16.8	38.1	17.5	17.5	34.9	7.1
1	1/2	1/4	11303-10116-10108-10104-	49.3	44.7	40.4	31.2	22.9	15.2	38.1	22.2	14.3	34.9	4.8
1	1/2	3/8	11303-10116-10108-10106-	49.3	44.7	41.9	31.2	22.9	16.8	38.1	22.2	17.5	34.9	7.1
1	1/2	1/2	11303-10116-10108-10108-	49.3	44.7	44.7	31.2	22.9	22.9	38.1	22.2	22.2	34.9	10.4
1	1/2	1	11303-10116-10108-10116-	49.3	44.7	49.3	31.2	22.9	31.2	38.1	22.2	38.1	34.9	10.4
1	5/8	3/8	11303-10116-10110-10106-	49.3	44.7	41.9	31.2	24.4	16.8	38.1	25.4	17.5	34.9	7.1
1	3/4	3/8	11303-10116-10112-10106-	49.3	44.7	41.9	31.2	24.4	16.8	38.1	28.6	17.5	34.9	7.1
1	3/4	1/2	11303-10116-10112-10108-	49.3	44.7	44.7	31.2	24.4	22.9	38.1	28.6	22.2	34.9	10.4
1	3/4	5/8	11303-10116-10112-10110-	49.3	44.7	44.7	31.2	24.4	24.4	38.1	28.6	25.4	34.9	12.7
1	3/4	1	11303-10116-10112-10116-	49.3	44.7	49.3	31.2	24.4	31.2	38.1	28.6	38.1	34.9	15.7
1	7/8	1/4	11303-10116-10114-10104-	49.3	44.7	40.4	31.2	25.9	15.2	38.1	31.8	14.3	34.9	4.8
1	7/8	3/8	11303-10116-10114-10106-	49.3	44.7	41.9	31.2	25.9	16.8	38.1	31.8	17.5	34.9	7.1
1	7/8	1/2	11303-10116-10114-10108-	49.3	44.7	44.7	31.2	25.9	22.9	38.1	31.8	22.2	34.9	10.4
1	7/8	3/4	11303-10116-10114-10112-	49.3	44.7	44.7	31.2	25.9	24.4	38.1	31.8	28.6	34.9	12.7
1	7/8	7/8	11303-10116-10114-10114-	49.3	44.7	44.7	31.2	25.9	25.9	38.1	31.8	31.8	34.9	18.3
1	1	1/4	11303-10116-10116-10104-	49.3	49.3	40.4	31.2	31.2	15.2	38.1	38.1	14.3	34.9	4.8
1	1	3/8	11303-10116-10116-10106-	49.3	49.3	41.9	31.2	31.2	16.8	38.1	38.1	17.5	34.9	7.1
1	1	1/2	11303-10116-10116-10108-	49.3	49.3	44.7	31.2	31.2	22.9	38.1	38.1	22.2	34.9	10.4
1	1	5/8	11303-10116-10116-10110-	49.3	49.3	44.7	31.2	31.2	24.4	38.1	38.1	25.4	34.9	12.7
1	1	3/4	11303-10116-10116-10112-	49.3	49.3	44.7	31.2	31.2	24.4	38.1	38.1	28.6	34.9	15.7
1	1	7/8	11303-10116-10116-10114-	49.3	49.3	44.7	31.2	31.2	25.9	38.1	38.1	31.8	34.9	18.3
1 1/4	1 1/4	1	11303-10120-10120-10116-	67.8	67.8	55.1	41.2	41.2	31.3	47.6	47.6	38.1	42.9	22.4
1 1/2	1 1/2	1	11303-10124-10124-10116-	78.7	78.7	60.0	50.0	50.0	31.3	57.2	57.2	38.1	50.8	22.4

Reducing Union Tees

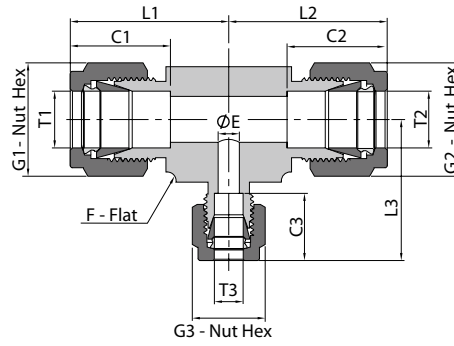

Metric Tube				Dimension,mm											
T1-Tube O.D. (mm)	T2-Tube O.D. (mm)	T3-Tube O.D. (mm)	Basic Ordering Number	L1	L2	L3	C1	C2	C3	G1	G2	G3	F	E	
3	3	6	11303-10203-10203-10206-	24.7	24.7	27.0	12.9	12.9	15.3	12	12	14	12.7	2.4	
6	6	3	11303-10206-10206-10203-	27.0	27.0	25.4	15.3	15.3	12.9	14	14	12	12.7	2.4	
6	6	8	11303-10206-10206-10208-	28.0	28.0	28.8	15.3	15.3	16.2	14	14	16	14.3	4.8	
8	8	6	11303-10208-10208-10206-	30.0	30.0	29.0	16.2	16.2	15.3	16	16	14	15.9	4.8	
8	8	12	11303-10208-10208-10212-	35.2	35.2	36.0	16.2	16.2	22.8	16	16	22	20.6	6.4	
10	10	6	11303-10210-10210-10206-	31.5	31.5	29.9	17.2	17.2	15.3	19	19	14	17.5	4.8	
10	10	8	11303-10210-10210-10208-	31.5	31.5	30.7	17.2	17.2	16.2	19	19	16	17.5	6.4	
12	12	6	11303-10212-10212-10206-	36.0	36.0	31.8	22.8	22.8	15.3	22	22	14	20.6	4.8	
12	12	8	11303-10212-10212-10208-	36.0	36.0	35.2	22.8	22.8	16.2	22	22	16	20.6	6.4	
12	12	14	11303-10212-10212-10214-	38.0	38.0	38.0	22.8	22.8	24.4	22	22	25	25.4	9.5	
12	12	18	11303-10212-10212-10218-	39.8	39.8	39.8	22.8	22.8	24.4	22	22	30	27.0	9.5	
14	14	8	11303-10214-10214-10208-	38.0	38.0	37.2	24.4	24.4	16.2	25	25	16	25.4	6.4	
14	14	10	11303-10214-10214-10210-	38.0	38.0	38.0	24.4	24.4	17.2	25	25	19	25.4	7.9	
15	15	12	11303-10215-10215-10212-	38.8	38.8	38.8	24.4	24.4	22.8	25	25	22	25.4	9.5	
16	8	16	11303-10216-10208-10216-	38.8	37.2	38.8	24.4	16.2	24.4	25	16	25	25.4	6.4	
16	16	12	11303-10216-10216-10212-	38.8	38.8	38.9	24.4	24.4	22.8	25	25	22	25.4	9.5	
18	18	8	11303-10218-10218-10208-	39.8	39.8	39.0	24.4	24.4	16.2	30	30	16	27.0	6.4	
18	18	10	11303-10218-10218-10210-	39.8	39.8	39.8	24.4	24.4	17.2	30	30	19	27.0	7.9	
18	18	12	11303-10218-10218-10212-	39.8	39.8	39.8	24.4	24.4	22.8	30	30	22	27.0	9.5	
18	18	14	11303-10218-10218-10214-	39.8	39.8	39.8	24.4	24.4	24.4	30	30	25	27.0	11.1	
20	20	14	11303-10220-10220-10214-	44.6	44.6	44.6	26.0	26.0	24.4	32	32	25	34.9	11.1	
22	22	12	11303-10222-10222-10212-	44.6	44.6	44.6	26.0	26.0	22.8	32	32	22	34.9	9.5	
25	25	12	11303-10225-10225-10212-	49.1	49.1	44.7	31.3	31.3	22.8	38	38	22	34.9	9.5	

Union Crosses

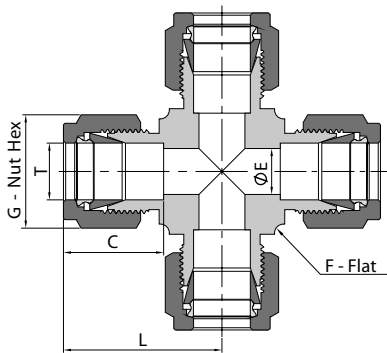

Caps

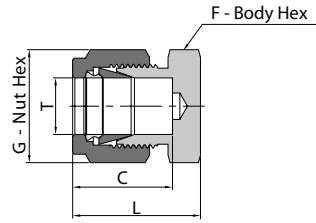

Fractional Tube						
T-Tube O.D. (in.)	Basic Ordering Number	Dimension,mm				
		L	C	G	F	E
1/8	11400-10102-	22.4	12.7	11.1	9.5	2.3
3/16	11400-10103-	24.4	13.7	12.7	11.1	3.0
1/4	11400-10104-	26.9	15.2	14.3	12.7	4.8
5/16	11400-10105-	29.7	16.2	15.9	15.9	6.4
3/8	11400-10106-	30.5	16.8	17.5	15.9	7.1
1/2	11400-10108-	36.1	22.9	22.2	20.6	10.4
5/8	11400-10110-	36.3	24.4	25.4	27.0	12.7
3/4	11400-10112-	39.9	24.4	28.6	27.0	15.7
7/8	11400-10114-	44.7	25.9	31.8	34.9	18.3
1	11400-10116-	49.0	31.2	38.1	34.9	22.4

Fractional Tube						
T-Tube O.D. (in.)	Basic Ordering Number	Dimension,mm				
		L	C	G	F	
1/16	11500-10101-	15.0	8.6	7.9	7.9	
1/8	11500-10102-	20.1	12.7	11.1	11.1	
3/16	11500-10103-	21.3	13.7	12.7	11.1	
1/4	11500-10104-	23.4	15.2	14.3	12.7	
5/16	11500-10105-	24.4	16.3	15.9	14.3	
3/8	11500-10106-	25.7	16.8	17.5	15.9	
1/2	11500-10108-	29.2	22.9	22.2	20.6	
5/8	11500-10110-	30.0	24.4	25.4	23.8	
3/4	11500-10112-	31.5	24.4	28.6	27.0	
7/8	11500-10114-	34.0	25.9	31.8	30.2	
1	11500-10116-	38.4	31.2	38.1	34.9	
1 1/8	11500-10118-	38.4	31.2	46.0	41.3	
1 1/4	11500-10120-	53.3	41.1	47.6	44.5	
1 1/2	11500-10124-	64.5	50.0	57.2	54.0	

Metric Tube						
T-Tube O.D. (mm)	Basic Ordering Number	Dimension,mm				
		L	C	G	F	E
3	11400-10203-	22.3	12.9	12	9.5	2.4
4	11400-10204-	25.4	13.7	12	12.7	2.4
6	11400-10206-	27.0	15.3	14	12.7	4.8
8	11400-10208-	29.9	16.2	16	15.9	6.4
10	11400-10210-	33.5	17.2	19	20.6	7.9
12	11400-10212-	36.0	22.8	22	20.6	9.5
16	11400-10216-	37.0	24.4	25	23.8	12.7
18	11400-10218-	38.3	24.4	30	27.0	15.1
20	11400-10220-	44.6	26.0	32	34.9	15.9
22	11400-10222-	44.7	26.0	32	34.9	18.3
25	11400-10225-	49.2	31.3	38	34.9	21.8

Metric Tube						
T-Tube O.D. (mm)	Basic Ordering Number	Dimension,mm				
		L	C	G	F	
2	11500-10202-	20.1	12.9	12	12	
3	11500-10203-	20.1	12.9	12	12	
4	11500-10204-	21.3	13.7	12	12	
6	11500-10206-	23.1	15.3	14	14	
8	11500-10208-	24.5	16.2	16	15	
10	11500-10210-	26.6	17.2	19	18	
12	11500-10212-	29.1	22.8	22	22	
14	11500-10214-	29.9	24.4	25	24	
15	11500-10215-	29.9	24.4	25	24	
16	11500-10216-	29.9	24.4	25	24	
18	11500-10218-	31.4	24.4	30	27	
20	11500-10220-	34.0	26.0	32	30	
22	11500-10222-	34.0	26.0	32	30	
25	11500-10225-	38.5	31.3	38	35	
28	11500-10228-	48.5	36.6	46	41	
30	11500-10230-	53.4	39.6	50	46	
32	11500-10232-	55.8	42.0	50	46	
38	11500-10238-	65.4	49.4	60	55	

Plugs

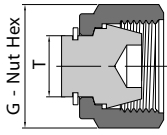

Fractional Tube		
T-Tube O.D. (in.)	Basic Ordering Number	Dimension,mm
		G
1/ 16	11510-10101-	7. 9
1/ 8	11510-10102-	11. 1
3/ 16	11510-10103-	12. 7
1/ 4	11510-10104-	14. 3
5/ 16	11510-10105-	15. 9
3/ 8	11510-10106-	17. 5
1/ 2	11510-10108-	22. 2
5/ 8	11510-10110-	25. 4
3/ 4	11510-10112-	28. 6
7/ 8	11510-10114-	31. 8
1	11510-10116-	38. 1
1 1/ 4	11510-10120-	47. 6
1 1/ 2	11510-10124-	57. 2

Metric Tube		
T-Tube O.D. (mm)	Basic Ordering Number	Dimension,mm
		G
2	11510-10202-	12
3	11510-10203-	12
4	11510-10204-	12
6	11510-10206-	14
8	11510-10208-	16
10	11510-10210-	19
12	11510-10212-	22
14	11510-10214-	25
15	11510-10215-	25
16	11510-10216-	25
18	11510-10218-	30
20	11510-10220-	32
22	11510-10222-	32
25	11510-10225-	38
28	11510-10228-	46
30	11510-10230-	50
32	11510-10232-	50
38	11510-10238-	60

Nuts

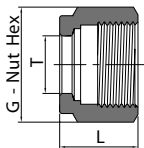

Fractional Tube			
T-Tube O.D. (in.)	Basic Ordering Number	Dimension,mm	
		L	G
1/ 16	11520-10101-	7. 9	7. 9
1/ 8	11520-10102-	11. 9	11. 1
3/ 16	11520-10103-	11. 9	12. 7
1/ 4	11520-10104-	12. 7	14. 3
5/ 16	11520-10105-	13. 5	15. 9
3/ 8	11520-10106-	14. 2	17. 5
1/ 2	11520-10108-	17. 5	22. 2
5/ 8	11520-10110-	17. 5	25. 4
3/ 4	11520-10112-	17. 5	28. 6
7/ 8	11520-10114-	17. 5	31. 8
1	11520-10116-	20. 6	38. 1
1 1/ 8	11520-10118-	30. 8	46. 0
1 1/ 4	11520-10120-	31. 8	47. 6
1 1/ 2	11520-10124-	38. 1	57. 2

Tube			
T-Tube O.D. (mm)	Basic Ordering Number	Dimension,mm	
		L	G
2	11520-10202-	11. 9	12
3	11520-10203-	11. 9	12
4	11520-10204-	11. 9	12
6	11520-10206-	12. 7	14
8	11520-10208-	13. 5	16
10	11520-10210-	15. 1	19
12	11520-10212-	17. 4	22
14	11520-10214-	17. 4	25
15	11520-10215-	17. 4	25
16	11520-10216-	17. 4	25
18	11520-10218-	17. 4	30
20	11520-10220-	17. 4	32
22	11520-10222-	17. 4	32
25	11520-10225-	20. 6	38
28	11520-10228-	30. 6	46
30	11520-10230-	32. 7	50
32	11520-10232-	34. 4	50
38	11520-10238-	40. 6	60

Front Ferrules

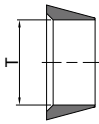

Rear Ferrules



Nut + Ferrules

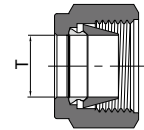

Fractional Tube	
T-Tube O.D. (in.)	Basic Ordering Number
1/16	11521-10101-
1/8	11521-10102-
3/16	11521-10103-
1/4	11521-10104-
5/16	11521-10105-
3/8	11521-10106-
1/2	11521-10108-
5/8	11521-10110-
3/4	11521-10112-
7/8	11521-10114-
1	11521-10116-
1 1/8	11521-10118-
1 1/4	11521-10120-
1	11521-10124-

Fractional Tube	
T-Tube O.D. (in.)	Basic Ordering Number
1/16	11522-10101-
1/8	11522-10102-
3/16	11522-10103-
1/4	11522-10104-
5/16	11522-10105-
3/8	11522-10106-
1/2	11522-10108-
5/8	11522-10110-
3/4	11522-10112-
7/8	11522-10114-
1	11522-10116-
1 1/8	11522-10118-
1 1/4	11522-10120-
1 1/2	11522-10124-

Fractional Tube	
T-Tube O.D. (in.)	Basic Ordering Number
1/16	11523-10101-
1/8	11523-10102-
3/16	11523-10103-
1/4	11523-10104-
5/16	11523-10105-
3/8	11523-10106-
1/2	11523-10108-
5/8	11523-10110-
3/4	11523-10112-
7/8	11523-10114-
1	11523-10116-
1 1/8	11523-10118-
1 1/4	11523-10120-
1 1/2	11523-10124-

Metric Tube	
T-Tube O.D. (mm)	Basic Ordering Number
2	11521-10202-
3	11521-10203-
4	11521-10204-
6	11521-10206-
8	11521-10208-
10	11521-10210-
12	11521-10212-
14	11521-10214-
15	11521-10215-
16	11521-10216-
18	11521-10218-
20	11521-10220-
22	11521-10222-
25	11521-10225-
28	11521-10228-
30	11521-10230-
32	11521-10232-
38	11521-10238-

Metric Tube	
T-Tube O.D. (mm)	Basic Ordering Number
2	11522-10202-
3	11522-10203-
4	11522-10204-
6	11522-10206-
8	11522-10208-
10	11522-10210-
12	11522-10212-
14	11522-10214-
15	11522-10215-
16	11522-10216-
18	11522-10218-
20	11522-10220-
22	11522-10222-
25	11522-10225-
28	11522-10228-
30	11522-10230-
32	11522-10232-
38	11522-10238-

Metric Tube	
T-Tube O.D. (mm)	Basic Ordering Number
2	11523-10202-
3	11523-10203-
4	11523-10204-
6	11523-10206-
8	11523-10208-
10	11523-10210-
12	11523-10212-
14	11523-10214-
15	11523-10215-
16	11523-10216-
18	11523-10218-
20	11523-10220-
22	11523-10222-
25	11523-10225-
28	11523-10228-
30	11523-10230-
32	11523-10232-
38	11523-10238-

Nut + Ferrules sets



Each Nut-Ferrule Sets contains 10 nuts, 10 front ferrules and 10 rear ferrules.

Fractional Tube	
T-Tube O.D. (in.)	Basic Ordering Number
1/ 16	11524-10101-
1/ 8	11524-10102-
3/ 16	11524-10103-
1/ 4	11524-10104-
5/ 16	11524-10105-
3/ 8	11524-10106-
1/ 2	11524-10108-
5/ 8	11524-10110-
3/ 4	11524-10112-

Metric Tube	
T-Tube O.D. (mm)	Basic Ordering Number
2	11524-10202-
3	11524-10203-
4	11524-10204-
6	11524-10206-
8	11524-10208-
10	11524-10210-
12	11524-10212-
14	11524-10214-
15	11524-10215-
16	11524-10216-
18	11524-10218-

Ferrules sets



Each Ferrule Set contains 10 front ferrules and 10 rear ferrules.

Fractional Tube	
T-Tube O.D. (in.)	Basic Ordering Number
1/ 16	11525-10101-
1/ 8	11525-10102-
3/ 16	11525-10103-
1/ 4	11525-10104-
5/ 16	11525-10105-
3/ 8	11525-10106-
1/ 2	11525-10108-
5/ 8	11525-10110-
3/ 4	11525-10112-

Metric Tube	
T-Tube O.D. (mm)	Basic Ordering Number
2	11525-10202-
3	11525-10203-
4	11525-10204-
6	11525-10206-
8	11525-10208-
10	11525-10210-
12	11525-10212-
14	11525-10214-
15	11525-10215-
16	11525-10216-
18	11525-10218-

Weld Connectors

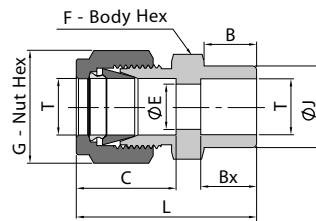

Fractional Tube		Tube Socket Weld							
T-Tube O.D. (in.)	Basic Ordering Number	Dimension,mm							
		L	C	G	F	B	E	Bx	J
1/8	11107-10102-	29.0	12.7	11.1	11.1	8.6	2.3	2.5	7.9
3/16	11107-10103-	29.7	13.7	12.7	11.1	9.5	3.3	4.8	10.7
1/4	11107-10104-	33.5	15.2	14.3	12.7	10.4	4.8	7.1	11.2
3/8	11107-10106-	37.6	16.8	17.5	15.9	11.9	7.1	7.9	15.7
1/2	11107-10108-	41.1	22.9	22.2	20.6	11.9	10.4	9.7	19.1
5/8	11107-10110-	41.9	24.4	25.4	23.8	11.9	12.7	10.4	23.4
3/4	11107-10112-	43.4	24.4	28.6	27.0	11.9	15.7	11.1	26.7
1	11107-10116-	52.6	31.2	38.1	34.9	14.2	22.4	15.7	33.3

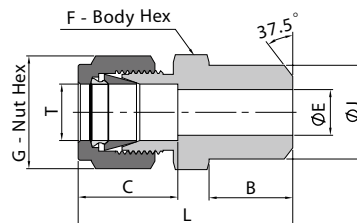

Fractional Tube			Pipe Butt Weld						
T-Tube O.D. (in.)	Pipe Weld Size	Basic Ordering Number	Dimension,mm						
			L	C	G	F	E	B	J
1/8	1/8	11107-10102-90102-	30.5	12.7	11.1	11.1	2.3	9.7	10.3
3/16	1/8	11107-10103-90102-	31.2	13.7	12.7	11.1	3.0	9.7	10.3
1/4	1/8	11107-10104-90102-	32.8	15.2	14.3	12.7	4.8	9.7	10.3
1/4	1/4	11107-10104-90104-	37.8	15.2	14.3	14.3	4.8	14.2	13.7
5/16	1/8	11107-10105-90102-	34.0	16.3	15.9	14.3	5.3	9.7	10.3
5/16	1/4	11107-10105-90104-	38.6	16.3	15.9	14.3	6.4	14.2	13.7
3/8	1/8	11107-10106-90102-	39.9	16.8	17.5	15.9	7.1	14.2	13.7
3/8	1/4	11107-10106-90104-	39.9	16.8	17.5	17.5	7.1	14.2	17.1
3/8	1/2	11107-10106-90108-	46.2	16.8	17.5	22.2	7.1	19.1	21.3
3/8	3/4	11107-10106-90112-	47.8	16.8	17.5	27.0	7.1	19.1	26.7
1/2	3/8	11107-10108-90106-	43.4	22.9	22.2	20.6	10.4	14.2	17.1
1/2	1/2	11107-10108-90108-	49.0	22.9	22.2	22.2	10.4	19.1	21.3
1/2	3/4	11107-10108-90112-	50.5	22.9	22.2	27.0	10.4	19.1	26.7
5/8	1/2	11107-10110-90108-	49.0	24.4	25.4	23.8	12.7	19.1	21.3
3/4	1/2	11107-10112-90108-	50.5	24.4	28.6	27.0	14.0	19.1	21.3
3/4	3/4	11107-10112-90112-	50.5	24.4	28.6	27.0	15.7	19.1	26.7
1	1	11107-10116-90116-	62.2	31.2	38.1	34.9	22.4	23.9	33.4
1 1/4	1 1/4	11107-10120-90120-	77.2	41.1	47.6	44.5	27.7	23.9	42.2
1 1/2	1 1/2	11107-10124-90124-	88.9	50.0	57.2	54.0	34.0	26.2	48.3

Weld Connectors

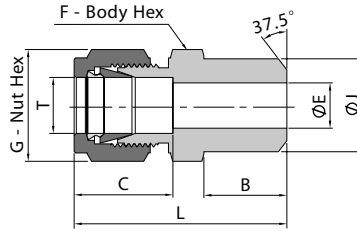

Metric Tube			Pipe Butt Weld						
T-Tube O.D. (mm)	Pipe Weld Size	Basic Ordering Number	Dimension,mm						
			L	C	G	F	E	B	J
3	1/8	11107-10203-90102-	30.5	12.9	12	12	2.4	9.7	10.3
4	1/8	11107-10204-90102-	31.5	13.7	12	12	2.4	9.7	10.3
6	1/8	11107-10206-90102-	32.8	15.3	14	14	4.8	9.7	10.3
6	1/4	11107-10206-90104-	37.9	15.3	14	14	4.8	14.2	13.7
8	1/8	11107-10208-90102-	34.2	16.2	16	15	5.4	9.7	10.3
8	1/4	11107-10208-90104-	38.7	16.2	16	15	6.4	14.2	13.7
8	1/2	11107-10208-90108-	45.6	16.2	16	22	6.4	19.1	21.3
10	1/8	11107-10210-90102-	40.9	17.2	19	18	7.5	14.2	13.7
10	1/4	11107-10210-90104-	40.9	17.2	19	18	7.9	14.2	17.2
10	1/2	11107-10210-90108-	46.5	17.2	19	22	7.9	19.1	21.3
12	1/4	11107-10212-90104-	43.4	22.8	22	22	7.5	14.2	13.7
12	3/8	11107-10212-90106-	43.4	22.8	22	22	9.5	14.2	17.1
12	1/2	11107-10212-90108-	49.0	22.8	22	22	9.5	19.1	21.3
14	3/8	11107-10214-90106-	44.1	24.4	25	24	10.7	14.2	17.1
15	1/2	11107-10215-90108-	49.0	24.4	25	24	11.9	19.1	21.3
16	1/2	11107-10216-90108-	49.0	24.4	25	24	12.7	19.1	21.3
18	1/2	11107-10218-90108-	50.5	24.4	30	27	13.9	19.1	21.3
30	1 1/4	11107-10230-90120-	77.2	39.6	50	46	26.2	23.9	42.2
32	1 1/4	11107-10232-90120-	79.6	42.0	50	46	28.6	23.9	42.2
38	1 1/2	11107-10238-90124-	91.6	49.4	60	55	33.7	26.2	48.3

Weld Elbows

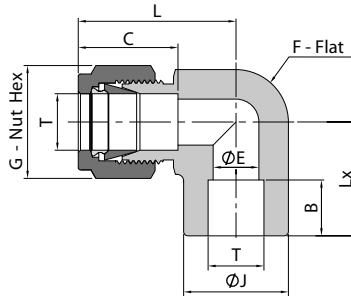

Fractional Tube		Tube socket Weld							
T-Tube O.D. (in.)	Basic Ordering Number	Dimension,mm							
		L	C	G	F	B	E	Lx	J
1/8	11207-10102-	16.8	12.7	11.1	9.5	2.5	2.3	16.0	9.7
3/16	11207-10103-	18.3	13.7	12.7	11.1	4.8	3.3	17.5	11.2
1/4	11207-10104-	26.9	15.2	14.3	12.7	7.1	4.8	19.6	12.7
3/8	11207-10106-	30.5	16.8	17.5	15.9	7.9	7.1	23.1	15.7
1/2	11207-10108-	36.1	22.9	22.2	20.6	9.7	10.4	25.9	20.6
5/8	11207-10110-	29.5	24.4	25.4	27.0	10.4	12.7	29.5	23.9
3/4	11207-10112-	39.9	24.4	28.6	27.0	11.2	15.7	29.7	26.9
1	11207-10116-	49.0	31.2	38.1	34.9	15.7	22.4	36.8	35.1

Weld Elbows

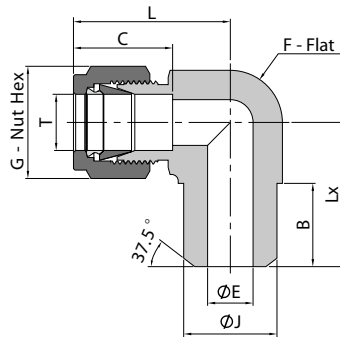

Fractional Tub			Pipe Butt Weld							
T-Tube O.D. (in.)	Pipe Weld Size	Basic Ordering Number	Dimension,mm							
			L	C	G	F	B	E	Lx	J
1/8	1/8	11207-10102-90102-	23.4	12.7	11.1	11.1	9.7	2.3	18.3	10.3
3/16	1/8	11207-10103-90102-	25.7	13.7	12.7	12.7	9.7	3.3	18.8	10.3
1/4	1/8	11207-10104-90102-	26.9	15.2	14.3	12.7	9.7	4.8	18.8	10.3
1/4	1/4	11207-10104-90104-	26.9	15.2	14.3	12.7	14.2	4.8	23.4	13.7
3/8	1/4	11207-10106-90104-	30.5	16.8	17.5	15.9	14.2	7.1	25.4	13.7
1/2	3/8	11207-10108-90106-	34.8	22.9	22.2	19.1	14.2	10.4	28.8	17.2
1/2	1/2	11207-10108-90108-	36.1	22.9	22.2	20.6	19.1	10.4	33.0	21.3
5/8	1/2	11207-10110-90108-	36.3	24.4	25.4	2.2	19.1	12.7	35.1	21.3
3/4	3/4	11207-10112-90112-	39.9	24.4	28.6	27.0	19.1	15.7	36.8	26.7
1	3/4	11207-10116-90112-	49.3	31.2	38.1	34.9	19.1	22.4	41.9	26.7
1	1	11207-10116-90116-	49.3	31.2	38.1	34.9	20.6	22.4	46.7	33.4

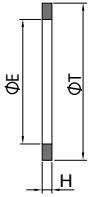

RG Gaskets

The RG gasket provides a seal on pressure gauges equipped with male ISO parallel threads.

ISO Parallel Thread Size	Basic Ordering Number	Dimension,mm		
		T	E	H
1/4	11532-102-	10.7	7.6	1.8
3/8	11532-106-	14.2	8.6	2.3
1/2	11532-108-	17.8	9.1	2.5

Metric Thread Size	Basic Ordering Number	Dimension,mm		
		T	E	H
M 10 x 1	11532-510-	8.3	3.3	1.5
M 12 x 1.5	11532-512-	9.7	5.4	2.0
M 14 x 1.5	11532-514-	11.7	6.4	
M 16 x 1.5	11532-516-	13.7	8.4	
M 18 x 1.5	11532-518-	15.7	10.0	
M 20 x 1.5	11532-520-	17.6	11.4	
M 22 x 1.5	11532-522-	19.6	13.4	
M 24 x 1.5	11532-524-	21.6	14.8	
M 27 x 2	11532-527-	24.0	13.9	2.5
M 30 x 2	11532-530-	27.0	19.5	
M 33 x 2	11532-533-	30.0	21.5	
M 36 x 2	11532-536-	33.0	23.5	
M 39 x 2	11532-539-	36.0	24.5	
M 42 x 2	11532-542-	38.9	29.5	
M 45 x 2	11532-545-	41.9	30.0	
M 48 x 2	11532-548-	44.9	32.5	

Ordering Information

Add the material designator as a suffix to the basic ordering number to complete the ordering number.

Example: 11532-514-B500, 11532-516-B600, 11532-520-B500

Material	Designator
Copper	B500
316L SS	B101
304L SS	B111
PTFE	B600